

P8H67-M PRO

ASUS[®]

Motherboard

E6149

First Edition (V1)
October 2010

Copyright © 2010 ASUSTeK Computer Inc. All Rights Reserved.

No part of this manual, including the products and software described in it, may be reproduced, transmitted, transcribed, stored in a retrieval system, or translated into any language in any form or by any means, except documentation kept by the purchaser for backup purposes, without the express written permission of ASUSTeK Computer Inc. ("ASUS").

Product warranty or service will not be extended if: (1) the product is repaired, modified or altered, unless such repair, modification or alteration is authorized in writing by ASUS; or (2) the serial number of the product is defaced or missing.

ASUS PROVIDES THIS MANUAL "AS IS" WITHOUT WARRANTY OF ANY KIND, EITHER EXPRESS OR IMPLIED, INCLUDING BUT NOT LIMITED TO THE IMPLIED WARRANTIES OR CONDITIONS OF MERCHANTABILITY OR FITNESS FOR A PARTICULAR PURPOSE. IN NO EVENT SHALL ASUS, ITS DIRECTORS, OFFICERS, EMPLOYEES OR AGENTS BE LIABLE FOR ANY INDIRECT, SPECIAL, INCIDENTAL, OR CONSEQUENTIAL DAMAGES (INCLUDING DAMAGES FOR LOSS OF PROFITS, LOSS OF BUSINESS, LOSS OF USE OR DATA, INTERRUPTION OF BUSINESS AND THE LIKE), EVEN IF ASUS HAS BEEN ADVISED OF THE POSSIBILITY OF SUCH DAMAGES ARISING FROM ANY DEFECT OR ERROR IN THIS MANUAL OR PRODUCT.

SPECIFICATIONS AND INFORMATION CONTAINED IN THIS MANUAL ARE FURNISHED FOR INFORMATIONAL USE ONLY, AND ARE SUBJECT TO CHANGE AT ANY TIME WITHOUT NOTICE, AND SHOULD NOT BE CONSTRUED AS A COMMITMENT BY ASUS. ASUS ASSUMES NO RESPONSIBILITY OR LIABILITY FOR ANY ERRORS OR INACCURACIES THAT MAY APPEAR IN THIS MANUAL, INCLUDING THE PRODUCTS AND SOFTWARE DESCRIBED IN IT.

Products and corporate names appearing in this manual may or may not be registered trademarks or copyrights of their respective companies, and are used only for identification or explanation and to the owners' benefit, without intent to infringe.

Offer to Provide Source Code of Certain Software

This product may contain copyrighted software that is licensed under the General Public License ("GPL") and under the Lesser General Public License Version ("LGPL"). The GPL and LGPL licensed code in this product is distributed without any warranty. Copies of these licenses are included in this product.

You may obtain the complete corresponding source code (as defined in the GPL) for the GPL Software, and/or the complete corresponding source code of the LGPL Software (with the complete machine-readable "work that uses the Library") for a period of three years after our last shipment of the product including the GPL Software and/or LGPL Software, which will be no earlier than December 1, 2011, either

(1) for free by downloading it from <http://support.asus.com/download>;

or

(2) for the cost of reproduction and shipment, which is dependent on the preferred carrier and the location where you want to have it shipped to, by sending a request to:

ASUSTeK Computer Inc.
Legal Compliance Dept.
15 Li Te Rd.,
Beitou, Taipei 112
Taiwan

In your request please provide the name, model number and version, as stated in the About Box of the product for which you wish to obtain the corresponding source code and your contact details so that we can coordinate the terms and cost of shipment with you.

The source code will be distributed WITHOUT ANY WARRANTY and licensed under the same license as the corresponding binary/object code.

This offer is valid to anyone in receipt of this information.

ASUSTeK is eager to duly provide complete source code as required under various Free Open Source Software licenses. If however you encounter any problems in obtaining the full corresponding source code we would be much obliged if you give us a notification to the email address gpl@asus.com, stating the product and describing the problem (please do NOT send large attachments such as source code archives etc to this email address).

Contents

Notices.....	vi
Safety information	vii
About this guide	vii
P8H67-M PRO specifications summary.....	ix

Chapter 1: Product introduction

1.1	Welcome!	1-1
1.2	Package contents	1-1
1.3	Special features	1-1
	1.3.1 Product highlights	1-1
	1.3.2 Innovative ASUS features.....	1-3
1.4	Before you proceed	1-5
1.5	Motherboard overview	1-6
	1.5.1 Placement direction	1-6
	1.5.2 Screw holes	1-6
	1.5.3 Motherboard layout.....	1-7
	1.5.4 Layout contents.....	1-7
1.6	Central Processing Unit (CPU)	1-8
	1.6.1 Installing the CPU	1-8
	1.6.2 Installing the CPU heatsink and fan.....	1-11
	1.6.3 Uninstalling the CPU heatsink and fan	1-12
1.7	System memory	1-13
	1.7.1 Overview	1-13
	1.7.2 Memory configurations.....	1-14
	1.7.3 Installing a DIMM	1-15
	1.7.4 Removing a DIMM	1-15
1.8	Expansion slots	1-16
	1.8.1 Installing an expansion card	1-16
	1.8.2 Configuring an expansion card	1-16
	1.8.3 PCI slots.....	1-16
	1.8.4 PCI Express x16 slots.....	1-16
1.9	Jumpers	1-17
1.10	Connectors	1-18
	1.10.1 Rear panel connectors.....	1-18

Contents

1.10.2	Internal connectors	1-20
1.11	Onboard switch	1-27
1.12	Onboard LEDs	1-28
1.13	Software support.....	1-29
1.13.1	Installing an operating system	1-29
1.13.2	Support DVD information	1-29

Chapter 2: BIOS information

2.1	Managing and updating your BIOS	2-1
2.1.1	ASUS Update utility	2-1
2.1.2	ASUS EZ Flash 2	2-2
2.1.3	ASUS CrashFree BIOS 3 utility	2-3
2.1.4	ASUS BIOS Updater	2-4
2.2	BIOS setup program	2-7
2.3	Main menu	2-11
2.3.1	System Language	2-11
2.3.2	System Date	2-11
2.3.3	System Time	2-11
2.3.4	Security	2-11
2.4	Ai Tweaker menu	2-13
2.4.1	Ai Overclock Tuner	2-13
2.4.2	Memory Frequency	2-14
2.4.3	GPU Boost	2-14
2.4.4	iGPU Max. Frequency.....	2-14
2.4.5	EPU Power Saving Mode	2-14
2.4.6	DRAM Timing Control	2-14
2.4.7	CPU Power Management	2-14
2.4.8	CPU Offset Mode Sign	2-15
2.4.9	iGPU Offset Mode Sign	2-15
2.4.10	DRAM Voltage	2-16
2.4.11	VCCIO Voltage	2-16
2.4.12	1.8FSR Voltage	2-16
2.4.13	PCH Voltage	2-16
2.4.14	Load-Line Calibration	2-16
2.4.15	CPU Spread Spectrum	2-16
2.5	Advanced menu	2-17

Contents

2.5.1	Trusted Computing.....	2-17
2.5.2	CPU Configuration.....	2-18
2.5.3	System Agent Configuration	2-19
2.5.4	PCH Configuration.....	2-19
2.5.6	USB Configuration.....	2-20
2.5.5	SATA Configuration.....	2-20
2.5.7	Onboard Devices Configuration.....	2-21
2.5.8	APM.....	2-23
2.6	Monitor menu	2-24
2.6.1	CPU Temperature / MB Temperature.....	2-24
2.6.2	CPU / Chassis / Power Fan Speed.....	2-24
2.6.3	CPU Q-Fan Control	2-25
2.6.4	Chassis Q-Fan Control	2-25
2.6.5	CPU Voltage, 3.3V Voltage, 5V Voltage, 12V Voltage ..	2-26
2.6.6	Anti Surge Support	2-26
2.7	Boot menu	2-27
2.7.1	Bootup NumLock State	2-27
2.7.2	Full Screen Logo	2-27
2.7.3	Post Report.....	2-27
2.7.4	Option ROM Messages	2-28
2.7.5	Setup Mode	2-28
2.7.6	Boot Option Priorities	2-28
2.7.7	Boot Override.....	2-28
2.8	Tools menu	2-29
2.8.1	ASUS EZ Flash 2.....	2-29
2.8.2	ASUS O.C. Profile.....	2-29
2.9	Exit menu	2-30

Notices

Federal Communications Commission Statement

This device complies with Part 15 of the FCC Rules. Operation is subject to the following two conditions:

- This device may not cause harmful interference, and
- This device must accept any interference received including interference that may cause undesired operation.

This equipment has been tested and found to comply with the limits for a Class B digital device, pursuant to Part 15 of the FCC Rules. These limits are designed to provide reasonable protection against harmful interference in a residential installation. This equipment generates, uses and can radiate radio frequency energy and, if not installed and used in accordance with manufacturer's instructions, may cause harmful interference to radio communications. However, there is no guarantee that interference will not occur in a particular installation. If this equipment does cause harmful interference to radio or television reception, which can be determined by turning the equipment off and on, the user is encouraged to try to correct the interference by one or more of the following measures:

- Reorient or relocate the receiving antenna.
- Increase the separation between the equipment and receiver.
- Connect the equipment to an outlet on a circuit different from that to which the receiver is connected.
- Consult the dealer or an experienced radio/TV technician for help.



The use of shielded cables for connection of the monitor to the graphics card is required to assure compliance with FCC regulations. Changes or modifications to this unit not expressly approved by the party responsible for compliance could void the user's authority to operate this equipment.

Canadian Department of Communications Statement

This digital apparatus does not exceed the Class B limits for radio noise emissions from digital apparatus set out in the Radio Interference Regulations of the Canadian Department of Communications.

This class B digital apparatus complies with Canadian ICES-003.

REACH

Complying with the REACH (Registration, Evaluation, Authorisation, and Restriction of Chemicals) regulatory framework, we published the chemical substances in our products at ASUS REACH website at <http://csr.asus.com/english/REACH.htm>.



DO NOT throw the motherboard in municipal waste. This product has been designed to enable proper reuse of parts and recycling. This symbol of the crossed out wheeled bin indicates that the product (electrical and electronic equipment) should not be placed in municipal waste. Check local regulations for disposal of electronic products.



DO NOT throw the mercury-containing button cell battery in municipal waste. This symbol of the crossed out wheeled bin indicates that the battery should not be placed in municipal waste.

Safety information

Electrical safety

- To prevent electric shock hazard, disconnect the power cable from the electric outlet before relocating the system.
- When adding or removing devices to or from the system, ensure that the power cables for the devices are unplugged before the signal cables are connected. If possible, disconnect all power cables from the existing system before you add a device.
- Before connecting or removing signal cables from the motherboard, ensure that all power cables are unplugged.
- Seek professional assistance before using an adapter or extension cord. These devices could interrupt the grounding circuit.
- Ensure that your power supply is set to the correct voltage in your area. If you are not sure about the voltage of the electrical outlet you are using, contact your local power company.
- If the power supply is broken, do not try to fix it by yourself. Contact a qualified service technician or your retailer.

Operation safety

- Before installing the motherboard and adding devices on it, carefully read all the manuals that came with the package.
- Before using the product, ensure that all cables are correctly connected and the power cables are not damaged. If you detect any damage, contact your dealer immediately.
- To avoid short circuits, keep paper clips, screws, and staples away from connectors, slots, sockets and circuitry.
- Avoid dust, humidity, and temperature extremes. Do not place the product in any area where it may become wet.
- Place the product on a stable surface.
- If you encounter technical problems with the product, contact a qualified service technician or your retailer.

About this guide

This user guide contains the information you need when installing and configuring the motherboard.

How this guide is organized

This guide contains the following parts:

- **Chapter 1: Product introduction**
This chapter describes the features of the motherboard and the new technology it supports.
- **Chapter 2: BIOS information**
This chapter tells how to change system settings through the BIOS Setup menus. Detailed descriptions of the BIOS parameters are also provided.

Conventions used in this guide

To ensure that you perform certain tasks properly, take note of the following symbols used throughout this manual.



DANGER/WARNING: Information to prevent injury to yourself when trying to complete a task.



CAUTION: Information to prevent damage to the components when trying to complete a task.



IMPORTANT: Instructions that you **MUST** follow to complete a task.



NOTE: Tips and additional information to help you complete a task.

Where to find more information

Refer to the following sources for additional information and for product and software updates.

1. ASUS websites

The ASUS website provides updated information on ASUS hardware and software products. Refer to the ASUS contact information.

2. Optional documentation

Your product package may include optional documentation, such as warranty flyers, that may have been added by your dealer. These documents are not part of the standard package.

Typography

Bold text

Indicates a menu or an item to select.

Italics

Used to emphasize a word or a phrase.

<Key>

Keys enclosed in the less-than and greater-than sign means that you must press the enclosed key.

Example: <Enter> means that you must press the Enter or Return key.

<Key1>+<Key2>+<Key3>

If you must press two or more keys simultaneously, the key names are linked with a plus sign (+).

Example: <Ctrl>+<Alt>+<D>

P8H67-M PRO specifications summary

CPU	<p>GA1155 socket for Intel® Second Generation Core™ i7 / Core™ i5 / Core™ i3 Processors</p> <p>Supports 32nm CPU</p> <p>Supports Intel® Turbo Boost Technology 2.0</p> <p>* The Intel® Turbo Boost Technology 2.0 support depends on the CPU types.</p> <p>** Refer to www.asus.com for Intel® CPU support list.</p>
Chipset	Intel® H67 Express Chipset
Memory	<p>Dual-channel memory architecture</p> <ul style="list-style-type: none"> - 4 x 240-pin DIMM sockets support unbuffered non-ECC DDR3 1333/1066MHz memory modules - Supports up to 32GB* system memory - Support Intel® Extreme Memory Profile (XMP) <p>* The Max. 32GB memory capacity can be supported with DIMMs of 8GB (or above). ASUS will update QVL once the DIMMs are available on market.</p> <p>** Hyper DIMM support is subject to the physical characteristics of individual CPUs. Some hyper DIMMs only support one DIMM per channel. Refer to Memory QVL for details.</p> <p>*** Refer to www.asus.com for the Memory QVL (Qualified Vendors Lists).</p> <p>****When you install a total memory of 4GB capacity or more, Windows® 32-bit operating system may only recognize less than 3GB. We recommend a maximum of 3GB system memory if you are using a Windows® 32-bit operating system.</p>
Expansion slots	<p>1 x PCI Express x16 slot (blue, x16 mode)</p> <p>1 x PCI Express x16 slot (x4 mode)</p> <p>2 x PCI slots</p>
Graphics	<p>Integrated graphics in Sandy Bridge CPU</p> <ul style="list-style-type: none"> - Supports D-Sub with max. resolution up to 2048 x 1536 @75Hz (4:3) - Supports DVI with max. resolution up to 1920 x 1200 @60Hz - Supports HDMI with max. resolution up to 1920 x 1200 @60Hz - Supports DirectX 10.1
Storage	<p>Intel® H67 Express Chipset:</p> <ul style="list-style-type: none"> - 4 x Serial ATA 3Gb/s connectors - 2 x Serial ATA 6Gb/s connectors - Intel® Rapid Storage technology supports RAID 0, 1, 5, 10 <p>VIA® VT6415</p> <ul style="list-style-type: none"> - 1 Ultra DMA 133/100 for up to 2 PATA devices
LAN	Realtek® 8111E Gigabit LAN controller

(continued on the next page)

P8H67-M PRO specifications summary

Audio	<p>ALC892 8-channel High Definition Audio CODEC supports</p> <ul style="list-style-type: none"> - Jack-detection, Multi-streaming, and Anti-POP technologies - Optical S/PDIF out ports at mid-board and back I/O - BD Audio Layer Content Protection
USB	<p>ASMedia 1042 controller:</p> <ul style="list-style-type: none"> - 2 x USB 3.0/2.0 ports (blue, at the back I/O) <p>Intel® H67 Express Chipset:</p> <ul style="list-style-type: none"> - 14 x USB 2.0/1.1 ports (10 ports at mid-board, 4 ports at the back panel)
ASUS Special features	<p>100% All High-quality Conductive Polymer Capacitors</p> <p>ASUS Exclusive Overclocking Features:</p> <ul style="list-style-type: none"> - GPU Boost - Turbo V - Auto Tuning* (Adopt Fast Mode) <p>ASUS Hybrid Switches</p> <ul style="list-style-type: none"> - MemOK! <p>ASUS Protect 3.0 technology</p> <ul style="list-style-type: none"> - ASUS EPU - Anti-Surge protection - LOW EMI solution <p>ASUS Quiet Thermal Solution</p> <ul style="list-style-type: none"> - ASUS Fanless Design: MOS+PCH Heatsink Solution <p>ASUS EZ DIY</p> <ul style="list-style-type: none"> - ASUS CrashFree BIOS 3 - ASUS O.C. Profile - ASUS EZ Flash 2 - ASUS MyLogo 2
Internal connectors	<p>5 x USB 2.0/1.1 connectors support additional 10 USB 2.0/1.1 ports</p> <ul style="list-style-type: none"> 1 x IDE connector 1 x System panel connector 1 x S/PDIF Out connector 4 x SATA 3.0 Gb/s connectors 2 x SATA 6.0 Gb/s connectors 1 x Front panel audio connector 1 x CPU fan connector 1 x Chassis fan connector 1 x Power fan connector 1 x COM connector 1 x LPT connector 1 x TPM connector 1 x 24-pin EATX Power connector 1 x 8-pin EATX 12V Power connector

(continued on the next page)

P8H67-M PRO specifications summary

Rear panel ports	1 x PS/2 Keyboard/Mouse COMBO port 1 x Optical S/PDIF out port 1 x LAN (RJ-45) port 1 x VGA port 1 x HDMI port 1 x DVI port 4 x USB 2.0/1.1 ports 2 x USB 3.0/2.0 ports 8-channel audio ports
BIOS features	32 Mb Flash ROM, EFI AMI BIOS, PnP, DMI v2.0, WfM2.0, SMBIOS v2.6, ACPI v2 0a
Manageability	WOL by PME, WOR by PME, WOR by Ring
Accessories	1 x UltraDMA 133/100 cable 2 x Serial ATA 6.0 Gb/s cable 1 x I/O shield User Manual
Support DVD	Drivers ASUS Update ASUS Utilities Anti-virus software (OEM version)
Form factor	MicroATX form factor: 9.6 in x 9.6 in (24.5 cm x 24.5 cm)

* Specifications are subject to change without notice.

Chapter 1

Product introduction

1.1 Welcome!

Thank you for buying an ASUS® P8H67-M PRO motherboard!

The motherboard delivers a host of new features and latest technologies, making it another standout in the long line of ASUS quality motherboards!

Before you start installing the motherboard, and hardware devices on it, check the items in your package with the list below.

1.2 Package contents

Check your motherboard package for the following items.

Motherboard	ASUS P8H67-M PRO motherboard
Cables	2 x Serial ATA 6.0Gb/s cables 1 x Ultra DMA 133/100 cable
Accessories	1 x I/O shield
Application DVD	ASUS motherboard support DVD
Documentation	User Manual



If any of the above items is damaged or missing, contact your retailer.

1.3 Special features

1.3.1 Product highlights



LGA1155 socket for Intel® Second Generation Core™ i7/ Core™ i5/ Core™ i3 Processors



This motherboard supports the Intel® Second Generation Core™ i7/ Core™ i5/ Core™ i3 processors in LGA1155 package with memory and PCI Express controllers integrated to support 2-channel (4 DIMMs) DDR3 memory and 16 PCI Express 2.0 lanes. This provides great graphics performance. Intel® Second Generation Core™ i7/ Core™ i5/ Core™ i3 processors are among the most powerful and energy efficient CPUs in the world.



Intel® H67 Express Chipset

The Intel® H67 Express Chipset is the latest single-chipset design to support the new 1155 socket Intel® Core™ i7 / Core™ i5 / Core™ i3 2nd generation processors. It provides improved performance by utilizing serial point-to-point links, allowing increased bandwidth and stability. Additionally, the H67 provides 2 SATA 6.0 Gb/s and 4 SATA 3.0 Gb/s ports for faster data retrieval at double the bandwidth of current bus systems.



Dual-Channel DDR3 1333 / 1066MHz support

The motherboard supports DDR3 memory that features data transfer rates of 1333 / 1066 MHz to meet the higher bandwidth requirements of the latest 3D graphics, multimedia, and Internet applications. The dual-channel DDR3 architecture enlarges the bandwidth of your system memory to boost system performance.



True Serial ATA 6Gb/s support

The Intel® H67 Express Chipset natively supports the Serial ATA (SATA) interface, delivering up to 6.0 Gb/s data transfer.



USB 3.0 support

Experience ultra-fast data transfer at 4.8Gbps with USB 3.0 – the latest connectivity standard. Built to connect easily with next-generation components and peripherals, USB 3.0 transfers data 10x faster and is also backward compatible with USB 2.0 components.



PCI Express 2.0 support

This motherboard supports PCI Express 2.0 devices for double speed and bandwidth which enhances system performance.



S/PDIF out connector at the back I/O

This motherboard provides convenient connectivity to external home theater audio systems via the optical S/PDIF (SONY-PHILIPS Digital Interface) out connector at the back I/O. The S/PDIF transfers digital audio without converting it to analog format and keeps the best signal quality.



8-channel high definition audio

The onboard 8-channel HD audio (High Definition Audio, previously codenamed Azalia) CODEC enables high-quality 192KHz/24-bit audio output and jack-detect feature that automatically detects and identifies what types of peripherals are plugged into the audio I/O jacks and notifies users of inappropriate connection, which means there will be no more confusion of Line-in, Line-out, and Mic jacks.



Gigabit LAN solution

The onboard LAN controller is a highly integrated Gb LAN controller. It is enhanced with an ACPI management function to provide efficient power management for advanced operating systems.



100% All High-quality Conductive Polymer Capacitors

This motherboard uses all high-quality conductive polymer capacitors for durability, improved lifespan, and enhanced thermal capacity.

1.3.2 Innovative ASUS features

ASUS EFI BIOS (EZ Mode)

ASUS brand new EFI BIOS offers a user-friendly interface that goes beyond traditional keyboard BIOS input to enable more flexible and convenient mouse controls. You can easily navigate the new EFI BIOS with the same smoothness as their operating system, while the exclusive EZ Mode displays frequently-accessed setup info, while the Advanced Mode is for experienced performance enthusiasts that demand far more intricate system settings.



MemOK!

MemOK! quickly ensures memory boot compatibility. This remarkable memory rescue tool requires a mere push of the button to patch memory issues. MemOK! determines failsafe settings and dramatically improves your system boot success. Get your system up and running in no time.



ASUS TurboV

Feel the adrenaline rush of real-time OC-now a reality with the ASUS TurboV. This easy OC tool allows you to overclock without exiting or rebooting the OS; and its user-friendly interface makes overclock with just a few clicks away. Moreover, the ASUS OC profiles in TurboV provides the best O.C. settings in different scenarios.



Auto Tuning

Auto Tuning is an intelligent tool that automates overclocking to achieve a total system level up. This tool also provides stability testing. Even O.C. beginners can achieve extreme yet stable overclocking results with Auto Tuning!



GPU Boost

GPU Boost overclocks the integrated GPU in real time for the best graphics performance. User-friendly UI facilitates flexible frequency and voltage adjustments. Its ability to deliver multiple overclocking profiles also provides rapid and stable system-level upgrades.



ASUS Anti-Surge Protection

This special design prevents expensive devices and the motherboard from damage caused by power surges from switching power supply (PSU).



AI Suite II

With its user-friendly interface, ASUS AI Suite II consolidates ASUS features into one simple to use software package. It allows you to supervise overclocking, energy management, fan speed control, voltage and sensor readings, and even interact with mobile devices via Bluetooth. All in one software offers diverse and ease to use functions, with no need to switch back and forth between different utilities.

Fanless Design: stylish heatsink solution

The Wing Heatsink features a 0-dB thermal solution that offers users a noiseless PC environment. The beautifully curved fins not only upgrade the visual enjoyment for motherboard users, but also effectively cools down hot airflows generated by the northbridge chipset. Combined with usability and aesthetics, the ASUS Wing Heatsink will give users an extremely silent and cooling experience with the elegant appearance!



ASUS MyLogo2™

This feature allows you to convert your favorite photo into a 256-color boot logo for a more colorful and vivid image on your screen.



ASUS CrashFree BIOS 3

ASUS CrashFree BIOS 3 is an auto-recovery tool that allows you to restore a corrupted BIOS file using the bundled support DVD or USB flash disk that contains the latest BIOS file.



ASUS EZ Flash 2

ASUS EZ Flash 2 is a utility that allows you to update the BIOS without using an OS-based utility.



C.P.R. (CPU Parameter Recall)

The BIOS C.P.R. feature automatically restores the CPU default settings when the system hangs due to overclocking failure. C.P.R. eliminates the need to open the system chassis and clear the RTC data. Simply shut down and reboot the system, and the BIOS automatically restores the CPU parameters to their default settings.



ErP ready

The motherboard is European Union's Energy-related Products (ErP) ready, and ErP requires products to meet certain energy efficiency requirements in regards to energy consumptions. This is in line with ASUS vision of creating environment-friendly and energy-efficient products through product design and innovation to reduce carbon footprint of the product and thus mitigate environmental impacts.

1.4 Before you proceed

Take note of the following precautions before you install motherboard components or change any motherboard settings.



- Unplug the power cord from the wall socket before touching any component.
 - Before handling components, use a grounded wrist strap or touch a safely grounded object or a metal object, such as the power supply case, to avoid damaging them due to static electricity.
 - Hold components by the edges to avoid touching the ICs on them.
 - Whenever you uninstall any component, place it on a grounded antistatic pad or in the bag that came with the component.
 - Before you install or remove any component, ensure that the ATX power supply is switched off or the power cord is detached from the power supply. Failure to do so may cause severe damage to the motherboard, peripherals, or components.
-

1.5 Motherboard overview

Before you install the motherboard, study the configuration of your chassis to ensure that the motherboard fits into it.



Ensure that you unplug the power cord before installing or removing the motherboard. Failure to do so can cause you physical injury and damage motherboard components.

1.5.1 Placement direction

When installing the motherboard, ensure that you place it into the chassis in the correct orientation. The edge with external ports goes to the rear part of the chassis as indicated in the image below.

1.5.2 Screw holes

Place eight screws into the holes indicated by circles to secure the motherboard to the chassis.



Do not overtighten the screws! Doing so can damage the motherboard.

Place this side towards
the rear of the chassis

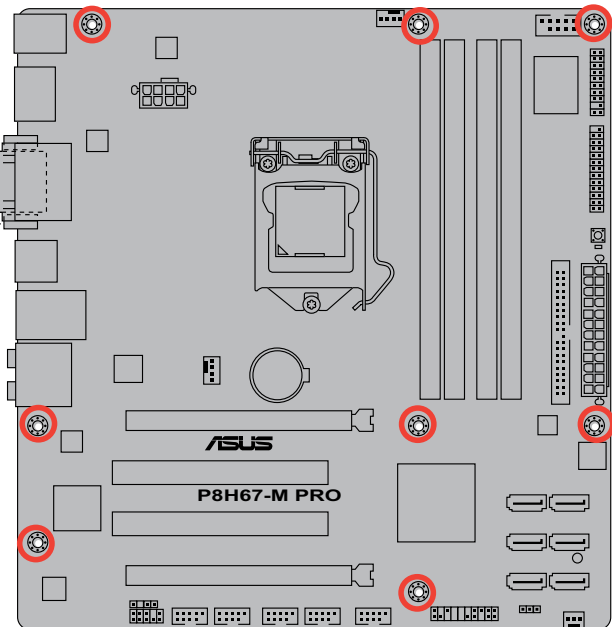

1.5.3 Motherboard layout

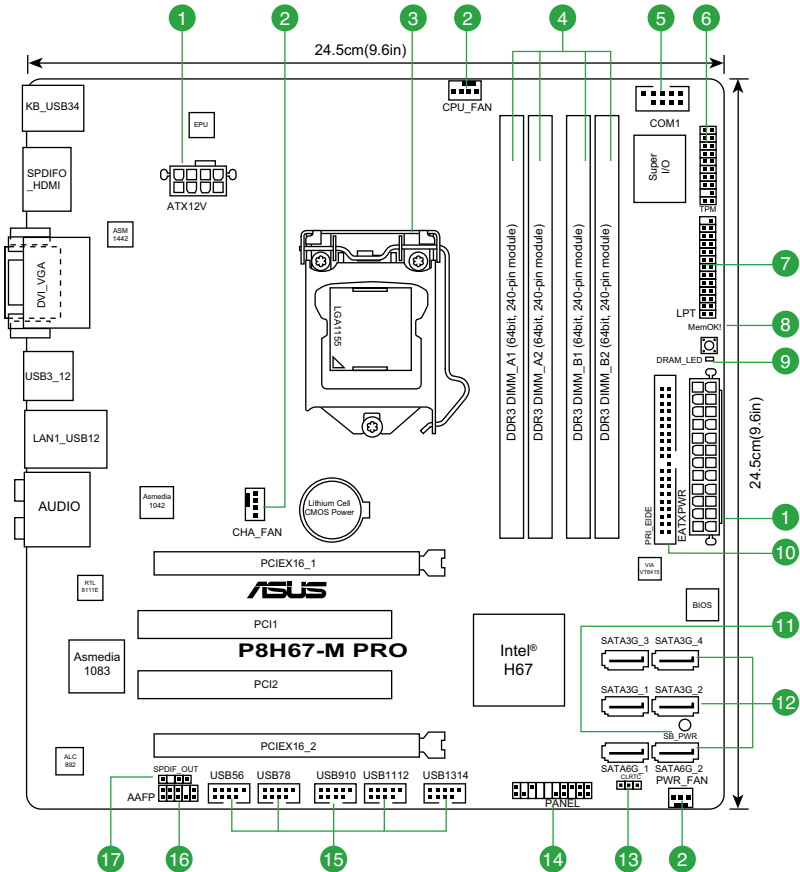

1.5.4 Layout contents

Connectors/Jumpers/Slots/LED	Page	Connectors/Jumpers/Slots/LED	Page
1. ATX power connectors (24-pin EATXPWR, 8-pin ATX12V)	1-22	10. IDE connector (40-1 pin PRI_EIDE)	1-24
2. CPU, Chassis, and Power fan connectors (4-pin CPU_FAN, 4-pin CHA_FAN, 3-pin PWR_FAN)	1-21	11. Onboard LED (SB_PWR)	1-28
3. Intel® CPU socket	1-8	12. Serial ATA connectors (7-pin SATA3G1-4, 7-pin SATA6G1-2)	1-20
4. DDR3 DIMM sockets	1-13	13. Clear RTC RAM (3-pin CLRRTC)	1-17
5. Serial port connectors (10-1 pin COM1)	1-21	14. System panel connector (20-8 pin F_PANEL)	1-25
6. TPM connector (20-1 pin TPM)	1-26	15. USB connectors (10-1 pin USB56, USB78, USB910, USB1112, USB1314)	1-23
7. LPT connector (26-1 pin LPT)	1-26	16. Front panel audio connector (10-1 pin AAFFP)	1-20
8. MemOK! switch	1-27	17. Digital audio connector (4-1 pin SPDIF_OUT)	1-23
9. DRAM LED	1-28		

1.6 Central Processing Unit (CPU)

The motherboard comes with a surface mount LGA1155 socket designed for the Intel® 2nd Generation Core™ i7 / Core™ i5 / Core™ i3 processors.



Unplug all power cables before installing the CPU.



- Upon purchase of the motherboard, ensure that the PnP cap is on the socket and the socket contacts are not bent. Contact your retailer immediately if the PnP cap is missing, or if you see any damage to the PnP cap/socket contacts/motherboard components. ASUS will shoulder the cost of repair only if the damage is shipment/transit-related.
- Keep the cap after installing the motherboard. ASUS will process Return Merchandise Authorization (RMA) requests only if the motherboard comes with the cap on the LGA1155 socket.
- The product warranty does not cover damage to the socket contacts resulting from incorrect CPU installation/removal, or misplacement/loss/incorrect removal of the PnP cap.

1.6.1 Installing the CPU

To install a CPU:

1. Locate the CPU socket on the motherboard.

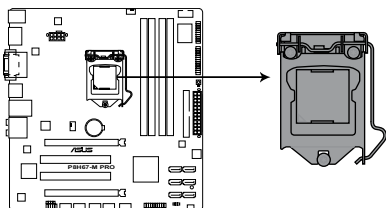

P8H67-M PRO CPU socket LGA1155

2. Press the load lever with your thumb (A), and then move it to the right (B) until it is released from the retention tab.



To prevent damage to the socket pins, do not remove the PnP cap unless you are installing a CPU.

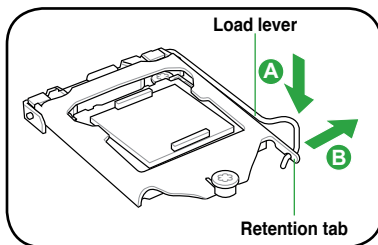

3. Lift the load lever in the direction of the arrow until the load plate is completely lifted.

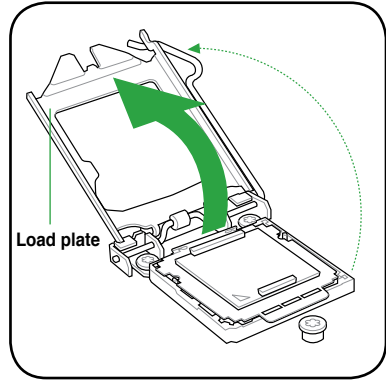

4. Remove the PnP cap from the CPU socket by lifting the tab only.

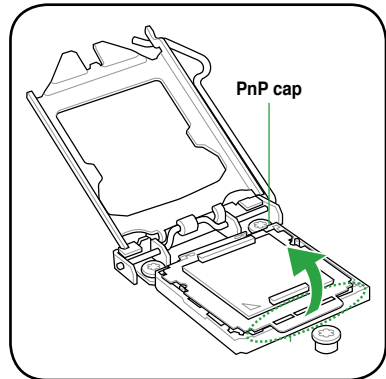

5. Position the CPU over the socket, ensuring that the gold triangle is on the bottom-left corner of the socket, and then fit the socket alignment keys into the CPU notches.



The CPU fits in only one correct orientation. DO NOT force the CPU into the socket to prevent bending the connectors on the socket and damaging the CPU!

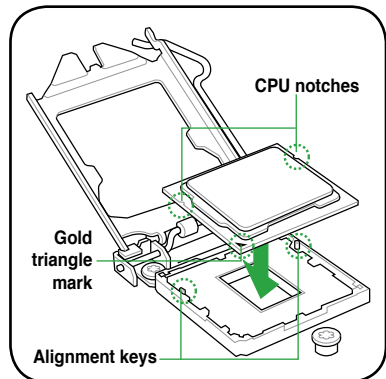

6. Apply some Thermal Interface Material to the exposed area of the CPU that the heatsink will be in contact with, ensuring that it is spread in an even thin layer.



Some heatsinks come with pre-applied thermal paste. If so, skip this step.



The Thermal Interface Material is toxic and inedible. DO NOT eat it. If it gets into your eyes or touches your skin, wash it off immediately, and seek professional medical help.

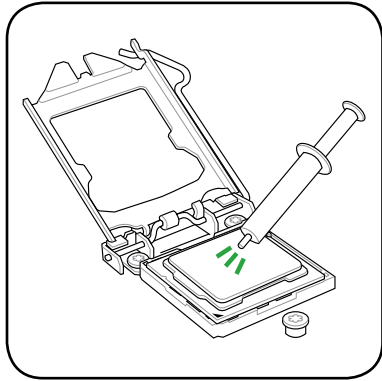

7. Close the load plate (A), and then push down the load lever (B), ensuring that the front edge of the load plate slides under the retention knob (C).

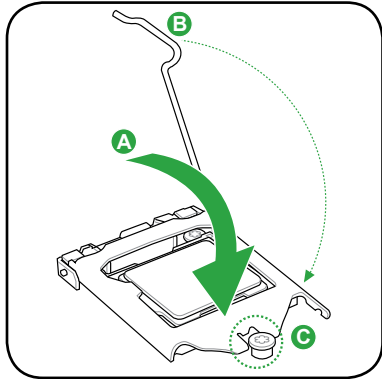

8. Insert the load lever under the retention tab.

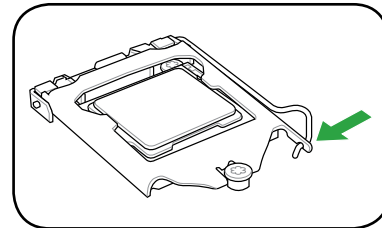

1.6.2 Installing the CPU heatsink and fan

The Intel® LGA1155 processor requires a specially designed heatsink and fan assembly to ensure optimum thermal condition and performance.



- When you buy a boxed Intel® processor, the package includes the CPU fan and heatsink assembly. If you buy a CPU separately, ensure that you use only Intel®-certified multi-directional heatsink and fan.
- Your Intel® LGA1155 heatsink and fan assembly comes in a push-pin design and requires no tool to install.
- Use an LGA1155-compatible CPU heatsink and fan assembly only. The LGA1155 socket is incompatible with the LGA775 and LGA1366 sockets in size and dimension.



If you purchased a separate CPU heatsink and fan assembly, ensure that you have properly applied Thermal Interface Material to the CPU heatsink or CPU before you install the heatsink and fan assembly.



Ensure that you have installed the motherboard to the chassis before you install the CPU fan and heatsink assembly.

To install the CPU heatsink and fan:

1. Place the heatsink on top of the installed CPU, ensuring that the four fasteners match the holes on the motherboard.



Orient the heatsink and fan assembly such that the CPU fan cable is closest to the CPU fan connector.

2. Push down two fasteners at a time in a diagonal sequence to secure the heatsink and fan assembly in place.

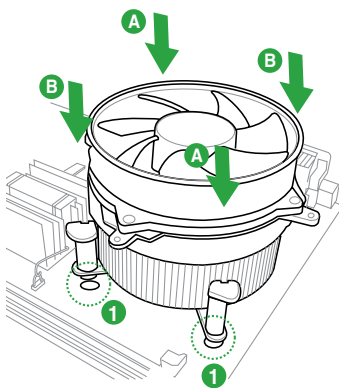
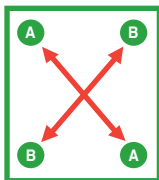

The type of CPU heatsink and fan assembly may differ, but the installation steps and functions should remain the same. The illustration above is for reference only.

3. Connect the CPU fan cable to the connector on the motherboard labeled CPU_FAN.

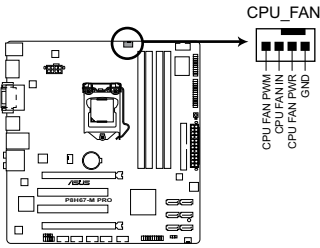

P8H67-M PRO CPU fan connector



Do not forget to connect the CPU fan connector! Hardware monitoring errors can occur if you fail to plug this connector.

1.6.3 Uninstalling the CPU heatsink and fan

To uninstall the CPU fan and fan:

1. Disconnect the CPU fan cable from the connector on the motherboard.
2. Rotate each fastener counterclockwise.
3. Pull up two fasteners at a time in a diagonal sequence to disengage the heatsink and fan assembly from the motherboard.

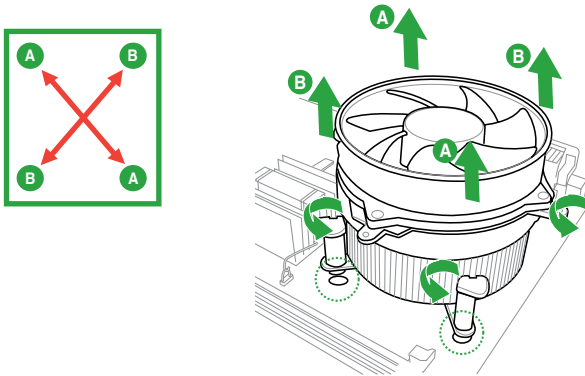

4. Carefully remove the heatsink and fan assembly from the motherboard.
5. Rotate each fastener clockwise to ensure correct orientation when reinstalling.

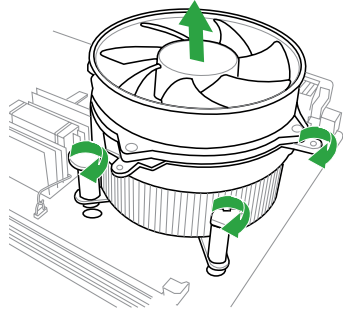

1.7 System memory

1.7.1 Overview

The motherboard comes with four Double Data Rate 3 (DDR3) Dual Inline Memory Modules (DIMM) sockets.

A DDR3 module has the same physical dimensions as a DDR2 DIMM but is notched differently to prevent installation on a DDR2 DIMM socket. DDR3 modules are developed for better performance with less power consumption.

The figure illustrates the location of the DDR3 DIMM sockets:

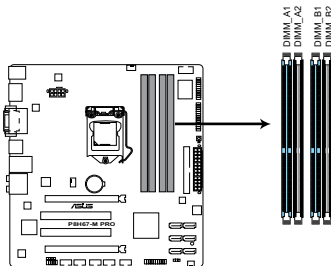

Channel	Sockets
Channel A	DIMM_A1 and DIMM_A2
Channel B	DIMM_B1 and DIMM_B2

P8H67-M PRO 240-pin DDR3 DIMM sockets

1.7.2 Memory configurations

You may install 512MB, 1GB, 2GB, and 4GB unbuffered non-ECC DDR3 DIMMs into the DIMM sockets.



-
- You may install varying memory sizes in Channel A and Channel B. The system maps the total size of the lower-sized channel for the dual-channel configuration. Any excess memory from the higher-sized channel is then mapped for single-channel operation.
 - According to Intel CPU specification, DIMM voltage below 1.65V is recommended to protect the CPU.
 - Always install DIMMs with the same CAS latency. For optimum compatibility, we recommend that you obtain memory modules from the same vendor.
 - Due to the memory address limitation on 32-bit Windows® OS, when you install 4GB or more memory on the motherboard, the actual usable memory for the OS can be about 3GB or less. For effective use of memory, we recommend that you do any of the following:
 - Use a maximum of 3GB system memory if you are using a 32-bit Windows® OS.
 - Install a 64-bit Windows® OS when you want to install 4GB or more on the motherboard.
 - This motherboard does not support DIMMs made up of 512Mb (64MB) chips or less.
-



-
- The default memory operation frequency is dependent on its Serial Presence Detect (SPD), which is the standard way of accessing information from a memory module. Under the default state, some memory modules for overclocking may operate at a lower frequency than the vendor-marked value. To operate at the vendor-marked or at a higher frequency, refer to section **2.4 Ai Tweaker menu** for manual memory frequency adjustment.
 - For system stability, use a more efficient memory cooling system to support a full memory load (4 DIMMs) or overclocking condition.
-



-
- ASUS exclusively provides hyper DIMM support function.
 - Hyper DIMM support is subject to the physical characteristics of individual CPUs.
 - Visit the ASUS website at www.asus.com for the latest QVL.
-

1.7.3 Installing a DIMM



Ensure to unplug the power supply before adding or removing DIMMs or other system components. Failure to do so may cause severe damage to both the motherboard and the components.

To install a DIMM

1. Unlock a DIMM socket by pressing the retaining clip outward.
2. Align a DIMM on the socket such that the notch on the DIMM matches the DIMM slot key on the socket.

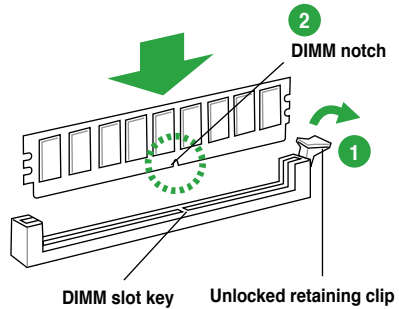

A DIMM is keyed with a notch so that it fits in only one direction. DO NOT force a DIMM into a socket in the wrong direction to avoid damaging the DIMM.

3. Firmly insert the DIMM into the socket until the retaining clip snaps back in place and the DIMM is properly seated.

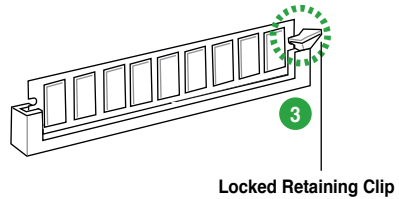

1.7.4 Removing a DIMM

Follow these steps to remove a DIMM.

1. Press the retaining clip outward to unlock the DIMM.



Support the DIMM lightly with your fingers when pressing the retaining clip. The DIMM might get damaged when it flips out with extra force.

2. Remove the DIMM from the socket.

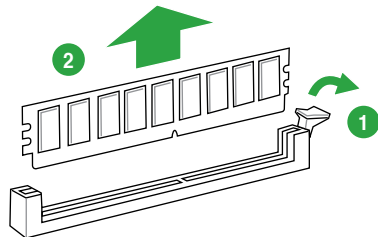

1.8 Expansion slots

In the future, you may need to install expansion cards. The following sub-sections describe the slots and the expansion cards that they support.



Unplug the power cord before adding or removing expansion cards. Failure to do so may cause you physical injury and damage motherboard components.

1.8.1 Installing an expansion card

To install an expansion card:

1. Before installing the expansion card, read the documentation that came with it and make the necessary hardware settings for the card.
2. Remove the system unit cover (if your motherboard is already installed in a chassis).
3. Remove the bracket opposite the slot that you intend to use. Keep the screw for later use.
4. Align the card connector with the slot and press firmly until the card is completely seated on the slot.
5. Secure the card to the chassis with the screw you removed earlier.
6. Replace the system cover.

1.8.2 Configuring an expansion card

After installing the expansion card, configure it by adjusting the software settings.

1. Turn on the system and change the necessary BIOS settings, if any. See Chapter 2 for information on BIOS setup.
2. Assign an IRQ to the card.
3. Install the software drivers for the expansion card.



When using PCI cards on shared slots, ensure that the drivers support "Share IRQ" or that the cards do not need IRQ assignments. Otherwise, conflicts will arise between the two PCI groups, making the system unstable and the card inoperable.

1.8.3 PCI slots

The PCI slots support cards such as a LAN card, SCSI card, USB card, and other cards that comply with PCI specifications.

1.8.4 PCI Express x16 slots

This motherboard has two PCI Express 2.0 x16 slots that support PCI Express x16 2.0 graphic cards complying with the PCI Express specifications.

VGA configuration	PCI Express operating mode	
	PCIe x16_1	PCIe x16_2
Single VGA/PCIe card	x16 (Recommended for single VGA card)	N/A
Dual VGA/PCIe card	x16	x4



- In single VGA card mode, use the PCIe 2.0 x16_1 slot (blue) for a PCI Express x16 graphics card to get better performance.
- We recommend that you provide sufficient power when running CrossFireX™ mode. See page 1-22 for details.
- Connect a chassis fan to the motherboard connector labeled CHA_FAN when using multiple graphics cards for better thermal environment.

1.9 Jumpers

1. Clear RTC RAM (3-pin CLRRTC)

This jumper allows you to clear the Real Time Clock (RTC) RAM in CMOS. You can clear the CMOS memory of date, time, and system setup parameters by erasing the CMOS RTC RAM data. The onboard button cell battery powers the RAM data in CMOS, which include system setup information such as system passwords.

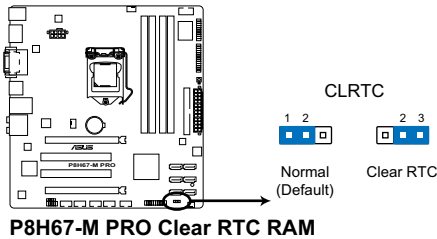

To erase the RTC RAM:

1. Turn OFF the computer and unplug the power cord.
2. Move the jumper cap from pins 1-2 (default) to pins 2-3 for about 5-10 seconds, then move the cap back to pins 1-2.
3. Plug the power cord and turn ON the computer.
4. Hold down the **** key during the boot process and enter BIOS setup to re-enter data.



Except when clearing the RTC RAM, never remove the cap on CLRRTC jumper default position. Removing the cap will cause system boot failure!



- If the steps above do not help, remove the onboard battery and move the jumper again to clear the CMOS RTC RAM data. After clearing the CMOS, reinstall the battery.
- You do not need to clear the RTC when the system hangs due to overclocking. For system failure due to overclocking, use the CPU Parameter Recall (C.P.R.) feature. Shut down and reboot the system, then the BIOS automatically resets parameter settings to default values.

1.10 Connectors

1.10.1 Rear panel connectors

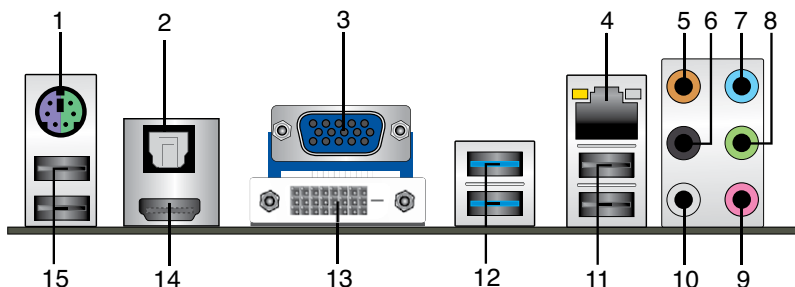

1. **PS/2 Keyboard/Mouse COMBO port.** This port is for a PS/2 keyboard/mouse.
2. **Optical S/PDIF Out port.** This port connects an external audio output device via an optical S/PDIF cable.
3. **Video Graphics Adapter (VGA) port.** This 15-pin port is for a VGA monitor or other VGA-compatible devices.
4. **LAN (RJ-45) port.** This port allows Gigabit connection to a Local Area Network (LAN) through a network hub. Refer to the table on the next page for the LAN port LED indicators.

LAN port LED indications

ACT/LINK LED		SPEED LED	
Status	Description	Status	Description
OFF	No link	OFF	10 Mbps connection
ORANGE	Linked	ORANGE	100 Mbps connection
BLINKING	Data activity	GREEN	1 Gbps connection

ACT/LINK LED SPEED LED

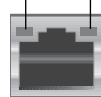

LAN port

5. **Center / Subwoofer port (orange).** This port connects the center/subwoofer speakers.
6. **Rear Speaker Out port (black).** This port connects the rear speakers in a 4-channel, 6-channel, or 8-channel audio configuration.
7. **Line In port (light blue).** This port connects the tape, CD, DVD player, or other audio sources.
8. **Line Out port (lime).** This port connects a headphone or a speaker. In 4-channel, 6-channel, and 8-channel configurations, the function of this port becomes Front Speaker Out.
9. **Microphone port (pink).** This port connects a microphone.
10. **Side Speaker Out port (gray).** This port connects the side speaker in an 8-channel audio configuration.



Refer to the audio configuration table on the next page for the function of the audio ports in the 2, 4, 6, or 8-channel configuration.

Audio 2, 4, 6, and 8-channel configuration

Port	Headset 2-channel	4-channel	6-channel	8-channel
Light Blue	Line In	Line in	Line in	Line in
Lime	Line Out	Front Speaker Out	Front Speaker Out	Front Speaker Out
Pink	Mic In	Mic In	Mic in	Mic in
Orange	-	-	Center/Subwoofer	Center/Subwoofer
Black	-	Rear Speaker Out	Rear Speaker Out	Rear Speaker Out
Gray	-	-	-	Side Speaker Out

- USB 2.0 ports 1 and 2.** These two 4-pin Universal Serial Bus (USB) ports connect to USB 2.0/1.1 devices.
- USB 3.0 ports 1 and 2.** These two 9-pin Universal Serial Bus (USB) ports connect to USB 3.0/2.0 devices.



- DO NOT connect a keyboard / mouse to any USB 3.0 port when installing Windows® operating system.
- Due to USB 3.0 controller limitation, USB 3.0 devices can only be used under Windows® OS environment and after the USB 3.0 driver installation.
- USB 3.0 devices can only be used as data storage only.
- We strongly recommend that you connect USB 3.0 devices to USB 3.0 ports for faster and better performance for your USB 3.0 devices.

- DVI port.** This port is for any DVI-D compatible device. DVI-D can't be converted to output RGB Signal to CRT and isn't compatible with DVI-I.
- HDMI port.** This port is for a High-Definition Multimedia Interface (HDMI) connector, and is HDCP compliant allowing playback of HD DVD, Blu-Ray and other protected content.



Dual display output support

- This table indicates that whether the following dual display outputs are supported for your motherboard:

Dual display outputs	Supported	Not supported
DVI + D-Sub	•	
DVI + HDMI	•	
HDMI + D-Sub	•	

- During POST, only the monitor connected to the D-Sub port has display. The dual display function works only under Windows.
- This motherboard also supports two add-on graphics card and two onboard VGA output at the same time.

- USB 2.0 ports 3 and 4.** These two 4-pin Universal Serial Bus (USB) ports connect to USB 2.0/1.1 devices.

1.10.2 Internal connectors

1. Front panel audio connector (10-1 pin AAFP)

This connector is for a chassis-mounted front panel audio I/O module that supports either High Definition Audio or AC'97 audio standard. Connect one end of the front panel audio I/O module cable to this connector.

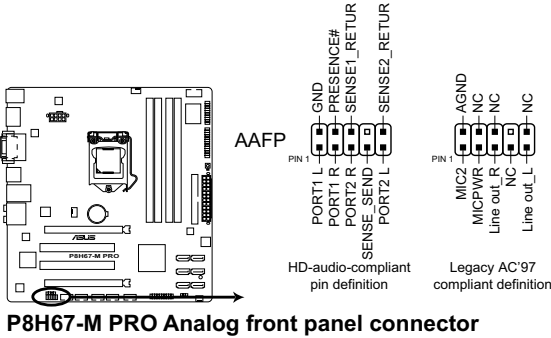

P8H67-M PRO Analog front panel connector



If you want to connect a high-definition front panel audio module to this connector, ensure that the **Front Panel Type** item in the BIOS is set to **[HD Audio]**. If you want to connect an AC97 front panel audio module to this connector, set the item to **[AC97]**. See section 2.5.7 **Onboard Devices Configuration** for details.

2. Serial ATA connectors (7-pin SATA3G1-4, 7-pin SATA6G1-2)

These connectors are for the Serial ATA signal cables for Serial ATA 3Gb/s or 6Gb/s hard disk and optical disk drives.

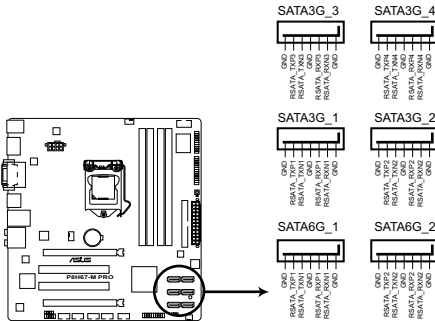

P8H67-M PRO SATA connectors



Install the Windows® XP Service Pack 2 or later version before using Serial ATA.

3. CPU, Chassis, and Power fan connectors (4-pin CPU_FAN, 3-pin PWR_FAN, 4-pin CHA_FAN)

Connect the fan cables to the fan connectors on the motherboard, making sure that the black wire of each cable matches the ground pin of the connector.



DO NOT forget to connect the fan cables to the fan connectors. Insufficient air flow inside the system may damage the motherboard components. They are not jumpers! DO NOT place jumper caps on the fan connectors.

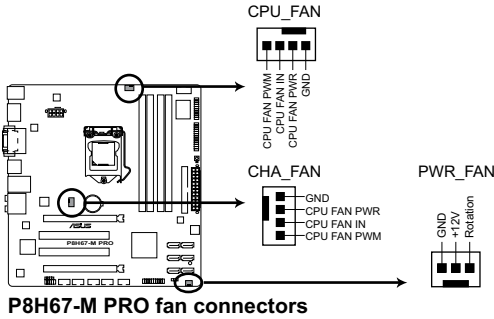

4. Serial port connectors (10-1 pin COM1)

The connector is for a serial (COM) port. Connect the serial port module cable to the connector, then install the module to a slot opening at the back of the system chassis.



The serial port bracket (COM1) is purchased separately.

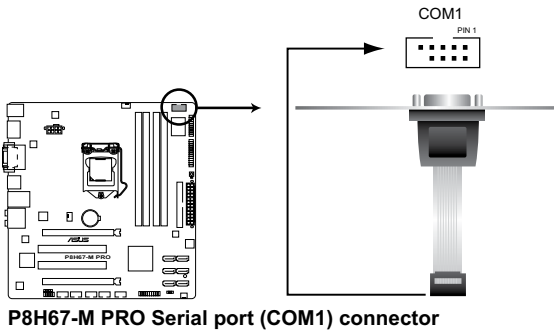

5. ATX power connectors (24-pin EATXPWR, 8-pin ATX12V)

These connectors are for an ATX power supply. The plugs from the power supply are designed to fit these connectors in only one orientation. Find the proper orientation and push down firmly until the connectors completely fit.

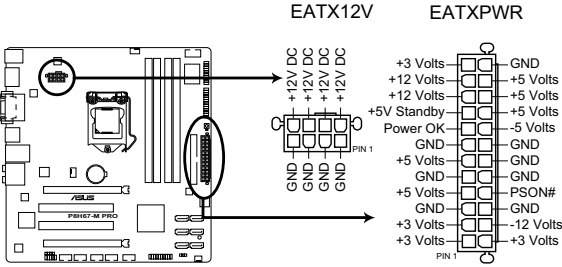

P8H67-M PRO ATX power connectors



- For a fully configured system, we recommend that you use a power supply unit (PSU) that complies with ATX 12 V Specification 2.0 (or later version) and provides a minimum power of 350 W.
- DO NOT forget to connect the 4-pin / 8-pin ATX +12V power plug. Otherwise, the system will not boot up.
- We recommend that you use a PSU with higher power output when configuring a system with more power-consuming devices or when you intend to install additional devices. The system may become unstable or may not boot up if the power is inadequate.
- If you are uncertain about the minimum power supply requirement for your system, refer to the Recommended Power Supply Wattage Calculator at <http://support.asus.com/PowerSupplyCalculator/PSCalculator.aspx?SLanguage=en-us> for details.

6. USB connectors (10-1 pin USB56, USB78, USB910, USB1112, USB1314)

These connectors are for USB 2.0 ports. Connect the USB module cable to any of these connectors, then install the module to a slot opening at the back of the system chassis. These USB connectors comply with the USB 2.0 specification that supports up to 480Mbps connection speed.

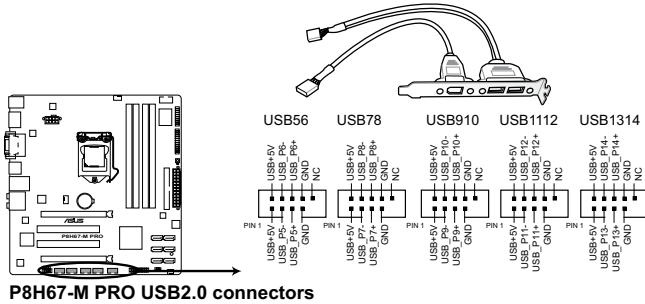

Never connect a 1394 cable to the USB connectors. Doing so will damage the motherboard!



The USB 2.0 module is purchased separately.

7. Digital audio connector (4-1 pin SPDIF_OUT)

This connector is for an additional Sony/Philips Digital Interface (S/PDIF) port.

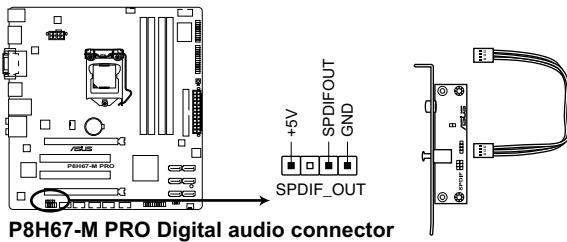

The S/PDIF module is purchased separately.

8. IDE connector (40-1 pin PRI_EIDE)

The onboard IDE connector is for Ultra DMA 133/100 signal cable. There are three connectors on each Ultra DMA 133/100 signal cable: blue, black, and gray. Connect the blue connector to the motherboard's IDE connector, then select one of the following modes to configure your devices:

	Drive jumper setting	Mode of device(s)	Cable connector
Single device	Cable-Select or Master	-	Black
Two devices	Cable-Select	Master	Black
		Slave	Gray
	Master	Master	Black or gray
	Slave	Slave	



- Pin 20 on the IDE connector is removed to match the covered hole on the Ultra DMA cable connector. This prevents incorrect insertion when you connect the IDE cable.
- Use the 80-conductor IDE cable for Ultra DMA 133/100 IDE devices.



If any device jumper is set as "Cable-Select", ensure that all other device jumpers have the same setting.

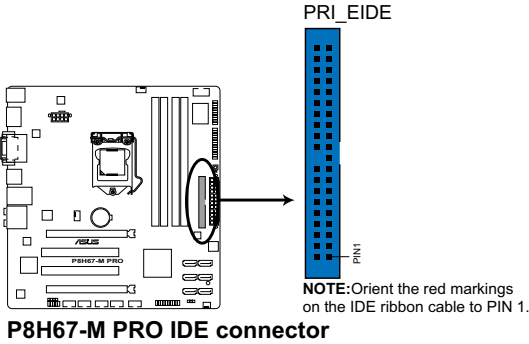

9. System panel connector (20-8 pin PANEL)

This connector supports several chassis-mounted functions.

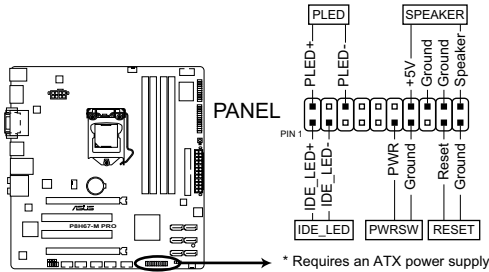

P8H67-M PRO System panel connector

- **System power LED (2-pin PLED)**

This 2-pin connector is for the system power LED. Connect the chassis power LED cable to this connector. The system power LED lights up when you turn on the system power, and blinks when the system is in sleep mode.

- **Hard disk drive activity LED (2-pin IDE_LED)**

This 2-pin connector is for the HDD Activity LED. Connect the HDD Activity LED cable to this connector. The IDE LED lights up or flashes when data is read from or written to the HDD.

- **System warning speaker (4-pin SPEAKER)**

This 4-pin connector is for the chassis-mounted system warning speaker. The speaker allows you to hear system beeps and warnings.

- **ATX power button/soft-off button (2-pin PWRSW)**

This 2-pin connector is for the system power button.

- **Reset button (2-pin RESET)**

This 2-pin connector is for the chassis-mounted reset button for system reboot without turning off the system power.

10. TPM connector (20-1 pin TPM)

This connector supports a Trusted Platform Module (TPM) system, which can securely store keys, digital certificates, passwords, and data. A TPM system also helps enhance network security, protects digital identities, and ensures platform integrity.

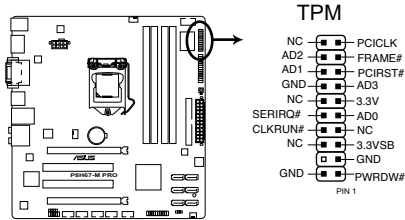

P8H67-M PRO TPM Connector



The TPM module is purchased separately.

11. LPT connector (26-1 pin LPT)

The LPT (Line Printing Terminal) connector supports devices such as a printer. LPT standardizes as IEEE 1284, which is the parallel port interface on IBM PC-compatible computers.

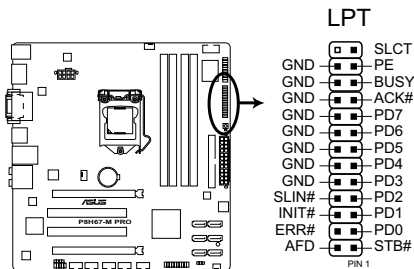

P8H67-M PRO Parallel Port Connector

1.11 Onboard switch

Onboard switch allows you to fine-tune performance when working on a bare or open-case system. This is ideal for overclockers and gamers who continually change settings to enhance system performance.

MemOK! switch

Installing DIMMs that are incompatible with the motherboard may cause system boot failure, and the DRAM_LED near the MemOK! switch lights continuously. Press and hold the MemOK! switch until the DRAM_LED starts blinking to begin automatic memory compatibility tuning for successful boot.

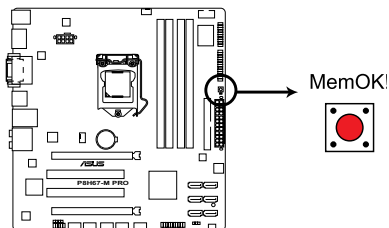

P8H67-M PRO MemOK! Switch



- Refer to section 1.12 **Onboard LEDs** for the exact location of the DRAM_LED.
- The DRAM_LED also lights when the DIMM is not properly installed. Turn off the system and reinstall the DIMM before using the MemOK! function.
- The MemOK! switch does not function under Windows® OS environment.
- During the tuning process, the system loads and tests failsafe memory settings. It takes about 30 seconds for the system to test one set of failsafe settings. If the test fails, the system reboots and test the next set of failsafe settings. The blinking speed of the DRAM_LED increases, indicating different test processes.
- Due to memory tuning requirement, the system automatically reboots when each timing set is tested. If the installed DIMMs still fail to boot after the whole tuning process, the DRAM_LED lights continuously. Replace the DIMMs with ones recommended in the Memory QVL (Qualified Vendors Lists) in this user manual or on the ASUS website at www.asus.com.
- If you turn off the computer and replace DIMMs during the tuning process, the system continues memory tuning after turning on the computer. To stop memory tuning, turn off the computer and unplug the power cord for about 5–10 seconds.
- If your system fail to boot due to BIOS overclocking, press the MemOK! switch to boot and load BIOS default settings. A message will appear during POST reminding you that the BIOS has been restored to its default settings.
- We recommend that you download and update to the latest BIOS version from the ASUS website at www.asus.com after using the MemOK! function.

1.12 Onboard LEDs

1. Standby Power LED

The motherboard comes with a standby power LED that lights up to indicate that the system is ON, in sleep mode, or in soft-off mode. This is a reminder that you should shut down the system and unplug the power cable before removing or plugging in any motherboard component. The illustration below shows the location of the onboard LED.

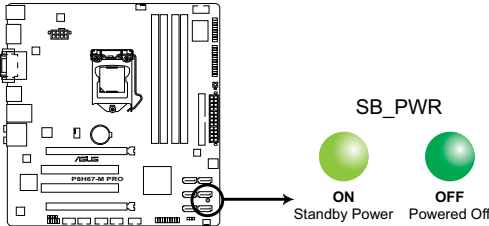

P8H67-M PRO Onboard LED

2. DRAM LED

DRAM LED checks the DRAM in sequence during motherboard booting process. If an error is found, the LED next to the error device will continue lighting until the problem is solved. This user-friendly design provides an intuitive way to locate the root problem within a second.

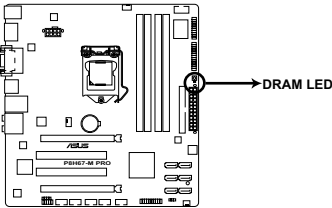

P8H67-M PRO DRAM LED

1.13 Software support

1.13.1 Installing an operating system

This motherboard supports Windows® XP / Vista / 7 Operating Systems (OS). Always install the latest OS version and corresponding updates to maximize the features of your hardware.



- Motherboard settings and hardware options vary. Refer to your OS documentation for detailed information.
- Ensure that you install Windows® XP Service Pack 3 or later versions / Windows® Vista Service Pack 1 or later versions before installing the drivers for better compatibility and system stability.

1.13.2 Support DVD information

The Support DVD that comes with the motherboard package contains the drivers, software applications, and utilities that you can install to avail all motherboard features.



The contents of the Support DVD are subject to change at any time without notice. Visit the ASUS website at www.asus.com for updates.

To run the Support DVD

Place the Support DVD to the optical drive. The DVD automatically displays the Drivers menu if Autorun is enabled in your computer.



The following screen is for reference only.

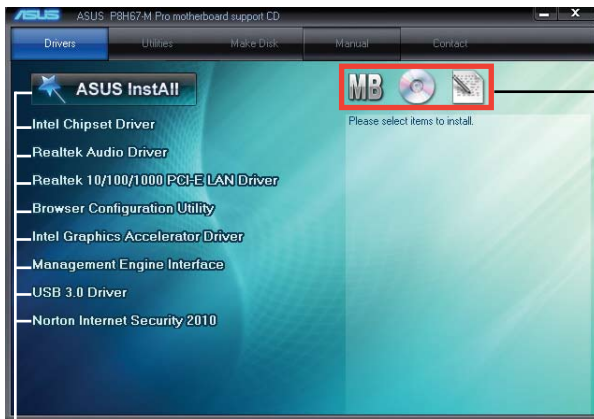

Click an icon to display Support DVD/motherboard information

Click an item to install



If Autorun is NOT enabled in your computer, browse the contents of the Support DVD to locate the file ASSETUP.EXE from the BIN folder. Double-click the ASSETUP.EXE to run the DVD.

Chapter 2

BIOS information

2.1 Managing and updating your BIOS



Save a copy of the original motherboard BIOS file to a USB flash disk in case you need to restore the BIOS in the future. Copy the original motherboard BIOS using the ASUS Update utility.

2.1.1 ASUS Update utility

The ASUS Update is a utility that allows you to manage, save, and update the motherboard BIOS in Windows® environment.



- ASUS Update requires an Internet connection either through a network or an Internet Service Provider (ISP).
 - This utility is available in the support DVD that comes with the motherboard package.
-

Installing ASUS Update

To install ASUS Update:

1. Place the support DVD in the optical drive. The **Drivers** menu appears.
2. Click the **Utilities** tab, then click **AI Suite II**.
3. Follow the onscreen instructions to complete the installation.



Quit all Windows® applications before you update the BIOS using this utility.

Updating the BIOS

To update the BIOS:

1. From the Windows® desktop, click **Start > Programs > ASUS > AI Suite II > AI Suite II X.XX.XX** to launch the AI Suite II utility. The AI Suite II Quick Bar appears.
2. Click **Update** button from the Quick Bar, and then click **ASUS Update** from the popup menu. The **ASUS Update** main screen appears. From the list, select either of the following methods:

Updating from the Internet

- a. Select **Update BIOS from the Internet**, then click **Next**.
- b. Select the ASUS FTP site nearest you to avoid network traffic, then click **Next**.
- c. From the FTP site, select the BIOS version that you wish to download then click **Next**.



The ASUS Update utility is capable of updating itself through the Internet. Always update the utility to avail all its features.

Updating from a BIOS file

- a. Select **Update BIOS from file**, then click **Next**.
 - b. Locate the BIOS file from the **Open** window, then click **Open**.
3. Follow the onscreen instructions to complete the updating process.

2.1.2 ASUS EZ Flash 2

The ASUS EZ Flash 2 feature allows you to update the BIOS without using an OS-based utility.



Before you start using this utility, download the latest BIOS file from the ASUS website at www.asus.com.

To update the BIOS using EZ Flash 2:

1. Insert the USB flash disk that contains the latest BIOS file to the USB port.
2. Enter the Advanced Mode of the BIOS setup program. Go to the **Tool** menu to select **ASUS EZ Flash Utility** and press **<Enter>** to enable it.

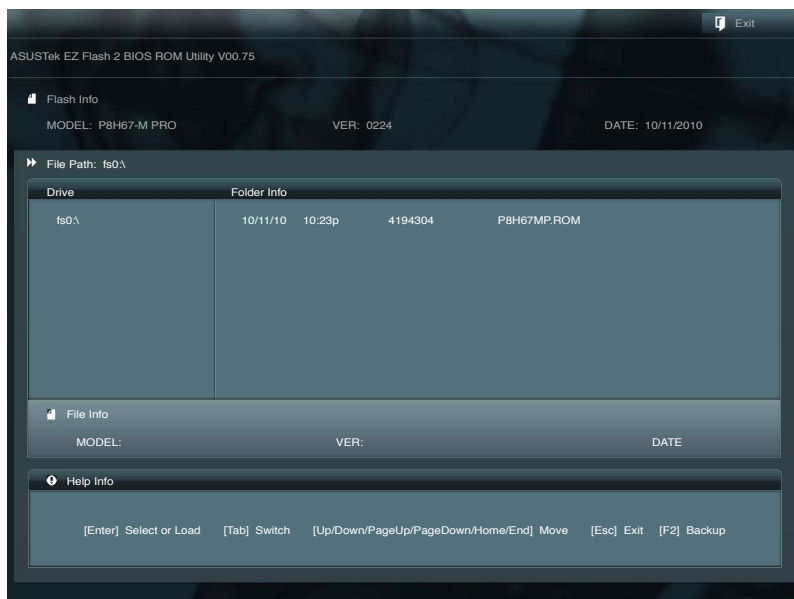

3. Press **<Tab>** to switch to the **Drive** field.
4. Press the Up/Down arrow keys to find the USB flash disk that contains the latest BIOS, and then press **<Enter>**.
5. Press **<Tab>** to switch to the **Folder Info** field.
6. Press the Up/Down arrow keys to find the BIOS file, and then press **<Enter>** to perform the BIOS update process. Reboot the system when the update process is done.



-
- This function supports USB flash disks with **FAT 32/16** format and single partition only.
 - **DO NOT** shut down or reset the system while updating the BIOS to prevent system boot failure!
-

2.1.3 ASUS CrashFree BIOS 3 utility

The ASUS CrashFree BIOS 3 is an auto recovery tool that allows you to restore the BIOS file when it fails or gets corrupted during the updating process. You can restore a corrupted BIOS file using the motherboard support DVD or a USB flash drive that contains the updated BIOS file.



The BIOS file in the support DVD may not be the latest version. Download the latest BIOS file from the ASUS website at www.asus.com.

Recovering the BIOS

To recover the BIOS:

1. Turn on the system.
2. Insert the support DVD to the optical drive or the USB flash drive that contains the BIOS file to the USB port.
3. The utility automatically checks the devices for the BIOS file. When found, the utility reads the BIOS file and enters ASUS EZ Flash 2 utility automatically.
4. The system requires you to enter BIOS Setup to recover BIOS setting. To ensure system compatibility and stability, we recommend that you press **<F5>** to load default BIOS values.



DO NOT shut down or reset the system while updating the BIOS! Doing so can cause system boot failure!

2.1.4 ASUS BIOS Updater

The ASUS BIOS Updater allows you to update BIOS in DOS environment. This utility also allows you to copy the current BIOS file that you can use as a backup when the BIOS fails or gets corrupted during the updating process.



The succeeding utility screens are for reference only. The actual utility screen displays may not be same as shown.

Before updating BIOS

1. Prepare the motherboard support DVD and a USB flash drive in FAT32/16 format and single partition.
2. Download the latest BIOS file and BIOS Updater from the ASUS website at <http://support.asus.com> and save them on the USB flash drive.



NTFS is not supported under DOS environment. Do not save the BIOS file and BIOS Updater to a hard disk drive or USB flash drive in NTFS format.

3. Turn off the computer and disconnect all SATA hard disk drives (optional).

Booting the system in DOS environment

1. Insert the USB flash drive with the latest BIOS file and BIOS Updater to the USB port.
2. Boot your computer. When the ASUS Logo appears, press <F8> to show the **BIOS Boot Device Select Menu**. Insert the support DVD into the optical drive and select the optical drive as the boot device.

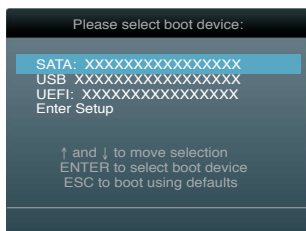

3. When the **Make Disk** menu appears, select the **FreeDOS command prompt** item by pressing the item number.
4. At the FreeDOS prompt, type **d:** and press <Enter> to switch the disk from Drive C (optical drive) to Drive D (USB flash drive).

```
Welcome to FreeDOS (http://www.freedos.org) !
C:\>d:
D:\>
```

Backing up the current BIOS

To backup the current BIOS file using the BIOS Updater



Ensure that the USB flash drive is not write-protected and has at least 4096KB free space to save the file.

1. At the FreeDOS prompt, type `bupdater /o [filename]` and press <Enter>.

```
D:\>bupdater /oOLDBIOS1_rom
```

Filename Extension

The [filename] is any user-assigned filename with no more than eight alphanumeric characters for the filename and three alphanumeric characters for the extension.

2. The BIOS Updater backup screen appears indicating the BIOS backup process. When BIOS backup is done, press any key to return to the DOS prompt.

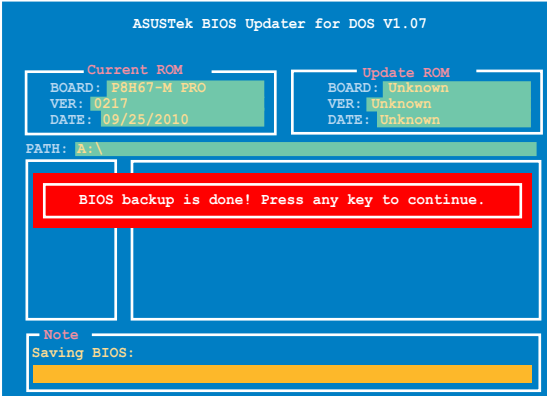

Updating the BIOS file

To update the BIOS file using BIOS Updater

1. At the FreeDOS prompt, type `bupdater /pc /g` and press <Enter>.

```
D:\>bupdater /pc /g
```

2. The BIOS Updater screen appears as below.

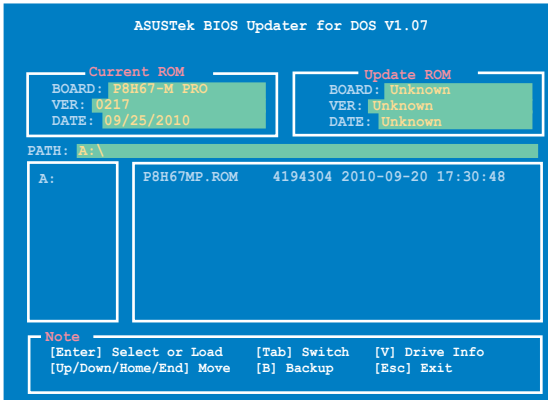

3. Press <Tab> to switch between screen fields and use the <Up/Down/Home/End> keys to select the BIOS file and press <Enter>. BIOS Updater checks the selected BIOS file and prompts you to confirm BIOS update.



4. Select Yes and press <Enter>. When BIOS update is done, press <ESC> to exit BIOS Updater. Restart your computer.



DO NOT shut down or reset the system while updating the BIOS to prevent system boot failure!



- For BIOS Updater version 1.04 or later, the utility automatically exits to the DOS prompt after updating BIOS.
- Ensure to load the BIOS default settings to ensure system compatibility and stability. Select the **Load Optimized Defaults** item under the Exit menu. Refer to section 2.9 **Exit menu** for details.
- Ensure to connect all SATA hard disk drives after updating the BIOS file if you have disconnected them.

2.2 BIOS setup program

Use the BIOS Setup program to update the BIOS or configure its parameters. The BIOS screens include navigation keys and brief online help to guide you in using the BIOS Setup program.

Entering BIOS Setup at startup

To enter BIOS Setup at startup:

- Press <Delete> during the Power-On Self Test (POST). If you do not press <Delete>, POST continues with its routines.

Entering BIOS Setup after POST

To enter BIOS Setup after POST:

- Press <Ctrl>+<Alt>+ simultaneously.
- Press the reset button on the system chassis.
- Press the power button to turn the system off then back on. Do this option only if you failed to enter BIOS Setup using the first two options.



Using the **power button**, **reset button**, or the <Ctrl>+<Alt>+ keys to force reset from a running operating system can cause damage to your data or system. We recommend to always shut down the system properly from the operating system.



-
- The BIOS setup screens shown in this section are for reference purposes only, and may not exactly match what you see on your screen.
 - Ensure that a USB mouse is connected to your motherboard if you want to use the mouse to control the BIOS setup program.
 - The default BIOS settings for this motherboard apply for most conditions to ensure optimum performance. If the system becomes unstable after changing any BIOS settings, load the default settings to ensure system compatibility and stability. Select the **Load Optimized Defaults** item under the Exit Menu. See section **2.9 Exit Menu**.
 - If the system fails to boot after changing any BIOS setting, try to clear the CMOS and reset the motherboard to the default value. Refer to section **1.9 Jumpers** on how to erase the RTC RAM.
 - The BIOS setup program does not support the bluetooth devices.
-

BIOS menu screen

The BIOS setup program can be used under two modes: EZ Mode and Advanced Mode. You can change modes from the Exit menu or from the Exit/Advanced Mode button in the EZ Mode/Advanced Mode screen.

EZ Mode

By default, the EZ Mode screen appears when you enter the BIOS setup program. The EZ Mode provides you an overview of the basic system information, and allows you to select the display language, system performance mode and boot device priority. To access the Advanced Mode, click Exit/Advanced Mode, then select Advanced Mode.



The default screen for entering the BIOS setup program can be changed. Refer to the **Setup Mode** item in section 2.7 **Boot menu** for details.

The screenshot shows the ASUS EFI BIOS Utility - EZ Mode interface. Key elements and their functions are as follows:

- Exit/Advanced Mode** (top right): Exits the BIOS setup program without saving the changes, saves the changes and resets the system, or enters the Advanced Mode.
- Language** (dropdown menu): Selects the display language of the BIOS setup program.
- Temperature, Voltage, Fan Speed** (middle section): Displays the CPU/motherboard temperature, CPU/5V/3.3V/12V voltage output, and CPU/chassis/power fan speed.
- System Performance** (bottom middle): Displays the system properties of the selected mode on the right hand side. Modes include Quiet, Performance, Energy Saving, Normal, and ASUS Optimal mode.
- Boot Priority** (bottom left): Selects the boot device priority. The selected mode is Normal.
- Boot Menu(F8)** (bottom right): Loads optimized default. Selects the boot device priority.
- Default(F5)** (bottom right): Loads optimized default.



- The boot device options vary depending on the devices you installed to the system.
- The **Boot Menu(F8)** button is available only when the boot device is installed to the system.

Advanced Mode

The Advanced Mode provides advanced options for experienced end-users to configure the BIOS settings. The figure below shows an example of the Advanced Mode. Refer to the following sections for the detailed configurations.



To access the EZ Mode, click **Exit**, then select **ASUS EZ Mode**.

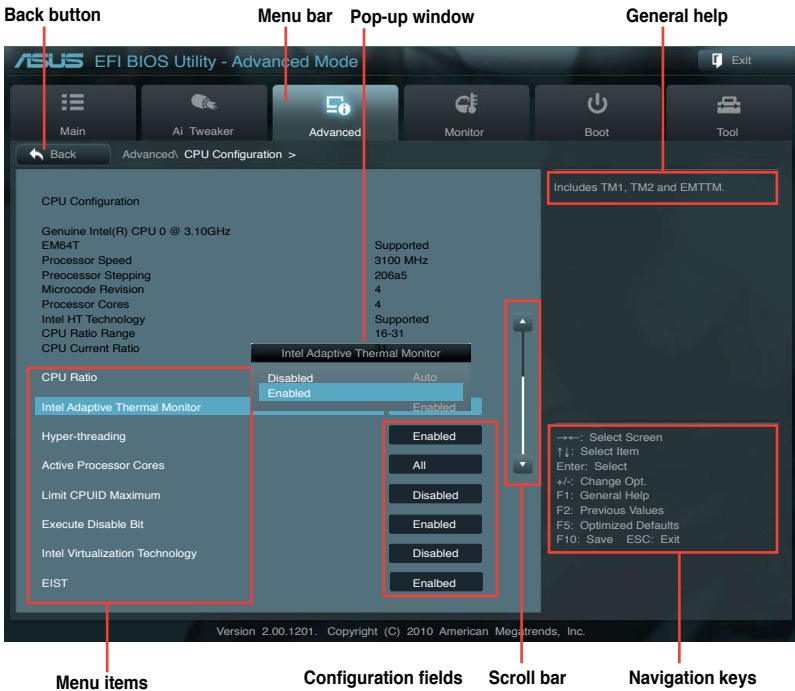

Menu bar

The menu bar on top of the screen has the following main items:

Main	For changing the basic system configuration
Ai Tweaker	For changing the overclocking settings
Advanced	For changing the advanced system settings
Monitor	For displaying the system temperature, power status, and changing the fan settings
Boot	For changing the system boot configuration
Tool	For configuring options for special functions
Exit	For selecting the exit options and loading default settings

Menu items

The highlighted item on the menu bar displays the specific items for that menu. For example, selecting **Main** shows the Main menu items.

The other items (Ai Tweaker, Advanced, Monitor, Boot, Tool, and Exit) on the menu bar have their respective menu items.

Back button

This button appears when entering a submenu. Press <Esc> or use the USB mouse to click this button to return to the previous menu screen.

Submenu items

A greater than sign (>) before each item on any menu screen means that the item has a submenu. To display the submenu, select the item and press <Enter> or double-click the item.

Pop-up window

Select a menu item and press <Enter> to display a pop-up window with the configuration options for that item.

Scroll bar

A scroll bar appears on the right side of a menu screen when there are items that do not fit on the screen. Press the Up/Down arrow keys or <Page Up> / <Page Down> keys to display the other items on the screen.

Navigation keys

At the bottom right corner of the menu screen are the navigation keys for the BIOS setup program. Use the navigation keys to select items in the menu and change the settings.

General help

At the top right corner of the menu screen is a brief description of the selected item.

Configuration fields

These fields show the values for the menu items. If an item is user-configurable, you can change the value of the field opposite the item. You cannot select an item that is not user-configurable.

A configurable field is highlighted when selected. To change the value of a field, select it and press <Enter> or click on it to display a list of options.

2.3 Main menu

The Main menu screen appears when you enter the Advanced Mode of the BIOS Setup program. The Main menu provides you an overview of the basic system information, and allows you to set the system date, time, language, and security settings.

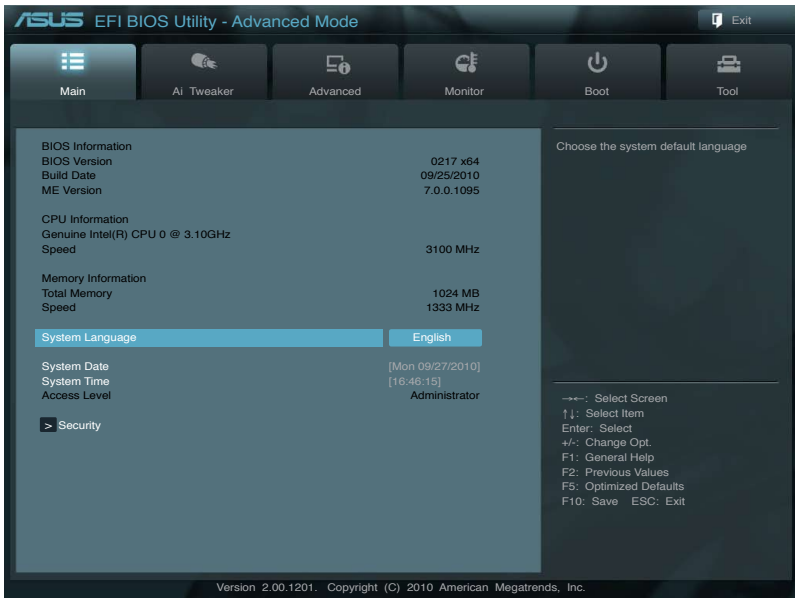

2.3.1 System Language [English]

Allows you to choose the BIOS language version from the options. Configuration options: [English] [Français] [Deutsch] [简体中文] [繁體中文] [日本語]

2.3.2 System Date [Day xx/xx/xxxx]

Allows you to set the system date.

2.3.3 System Time [xx:xx:xx]

Allows you to set the system time.

2.3.4 Security

The Security menu items allow you to change the system security settings.



- If you have forgotten your BIOS password, erase the CMOS Real Time Clock (RTC) RAM to clear the BIOS password. See section 1.9 **Jumpers** for information on how to erase the RTC RAM.
- The **Administrator** or **User Password** items on top of the screen show the default **Not Installed**. After you set a password, these items show **Installed**.

Administrator Password

If you have set an administrator password, we recommend that you enter the administrator password for accessing the system. Otherwise, you might be able to see or change only selected fields in the BIOS setup program.

To set an administrator password:

1. Select the **Administrator Password** item and press <Enter>.
2. From the **Create New Password** box, key in a password, then press <Enter>.
3. Confirm the password when prompted.

To change an administrator password:

1. Select the **Administrator Password** item and press <Enter>.
2. From the **Enter Current Password** box, key in the current password, then press <Enter>.
3. From the **Create New Password** box, key in a new password, then press <Enter>.
4. Confirm the password when prompted.

To clear the administrator password, follow the same steps as in changing an administrator password, but press <Enter> when prompted to create/confirm the password. After you clear the password, the **Administrator Password** item on top of the screen shows **Not Installed**.

User Password

If you have set a user password, you must enter the user password for accessing the system. The **User Password** item on top of the screen shows the default **Not Installed**. After you set a password, this item shows **Installed**.

To set a user password:

1. Select the **User Password** item and press <Enter>.
2. From the **Create New Password** box, key in a password, then press <Enter>.
3. Confirm the password when prompted.

To change a user password:

1. Select the **User Password** item and press <Enter>.
2. From the **Enter Current Password** box, key in the current password, then press <Enter>.
3. From the **Create New Password** box, key in a new password, then press <Enter>.
4. Confirm the password when prompted.

To clear the user password, follow the same steps as in changing a user password, but press <Enter> when prompted to create/confirm the password. After you clear the password, the **User Password** item on top of the screen shows **Not Installed**.

2.4 Ai Tweaker menu

The Ai Tweaker menu items allow you to configure overclocking-related items.



Be cautious when changing the settings of the Ai Tweaker menu items. Incorrect field values can cause the system to malfunction.



The configuration options for this section vary depending on the CPU and DIMM model you installed on the motherboard.

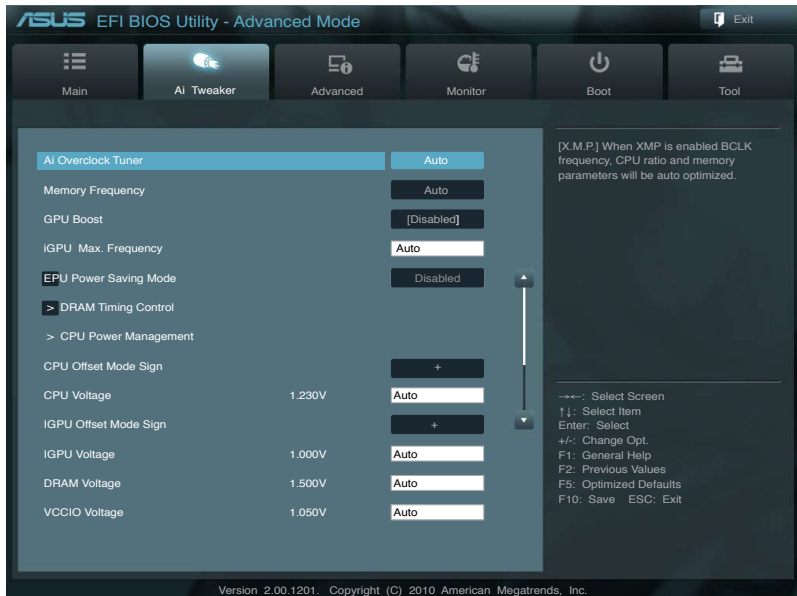

2.4.1 Ai Overclock Tuner [Auto]

Allows you to select the CPU overclocking options to achieve the desired CPU internal frequency. Select any of these preset overclocking configuration options:

- [Auto] Loads the optimal settings for the system.
- [Manual] Allows you to individually set overclocking parameters.
- [X.M.P.] If you install memory modules supporting the eXtreme Memory Profile (X.M.P.) Technology, choose this item to set the profiles supported by your memory modules for optimizing the system performance.

BCLK/PEG Frequency [XXX]

Appears when you set the **Ai Overclock Tuner** item to **[Manual]** and allows you to adjust the CPU and VGA frequency to enhance the system performance. Use the <+> and <-> keys to adjust the value. You can also key in the desired value using the numeric keypad. The values range from 80.0MHz to 300.0MHz.

2.4.2 Memory Frequency [Auto]

Allows you to set the memory operating frequency. Configuration options: [Auto] [DDR3-800MHz] [DDR3-1066MHz] [DDR3-1333MHz]



Selecting a very high memory frequency may cause the system to become unstable! If this happens, revert to the default setting.

2.4.3 GPU Boost [Disabled]

Allows you to enable or disable the GPU Boost function.
Configuration options: [Disabled] [Enabled]

2.4.4 iGPU Max. Frequency

Allows you to set the iGPU maximum frequency. The values range from 1100MHz to 3000MHz with a 50MHz interval. Use <+>/<-> to adjust the value.

2.4.5 EPU Power Saving Mode [Disabled]

Allows you to enable or disable the EPU power saving function.
Configuration options: [Disabled] [Enabled]

EPU Setting [AUTO]

This item appears only when you set the **EPU Power Saving Mode** item to [Enabled] and allows you to select the EPU power saving mode. Configuration options: [AUTO] [Light Power Saving Mode] [Medium Power Saving Mode] [Max Power Saving Mode]

2.4.6 DRAM Timing Control

The sub-items in this menu allow you to set the DRAM timing control features. Use the <+> and <-> keys to adjust the value. To restore the default setting, type [auto] using the keyboard and press <Enter>.



Changing the values in this menu may cause the system to become unstable! If this happens, revert to the default settings.

2.4.7 CPU Power Management

The sub-items in this menu allow you to set the CPU ratio and features.

CPU Ratio [Auto]

Allows you to manually adjust the maximum non-turbo CPU ratio. Use <+> and <-> keys or the numeric keypad to adjust the ratio. The valid value ranges vary according to your CPU model.

Enhanced Intel SpeedStep Technology [Enabled]

Allows you to enable or disable the Enhanced Intel® SpeedStep Technology (EIST).

[Disabled] Disables this function.

[Enabled] The operating system dynamically adjusts the processor voltage and core frequency which may result in increased average consumption and decrease average heat production.

Turbo Mode [Enabled]

This item appears only when you set the **EIST** item to [Enabled].

[Enabled] Allows processor cores to run faster than marked frequency in specific conditions.

[Disabled] Disables this function.



The following three items appear only when you set both the **EIST** and **Turbo Mode** items to [Enabled].

Long duration power limit [Auto]

Use <+>/<-> to adjust the value.

Long duration maintained [Auto]

Use <+>/<-> to adjust the value.

Short duration power limit [Auto]

Use <+>/<-> to adjust the value.

Primary Plane Current Limit [Auto]

Use <+>/<-> to adjust the value.

Secondary Plane Current Limit [Auto]

Use <+>/<-> to adjust the value.



Some of the following items are adjusted by typing the desired values using the numeric keypad and press <Enter>. You can also use the <+> and <-> keys to adjust the value. To restore the default setting, type [auto] using the keyboard and press <Enter>.

2.4.8 CPU Offset Mode Sign [+]

This item appears when the EPU Power Saving Mode item is set to [Disabled].

[+] To offset the voltage by a positive value.

[-] To offset the voltage by a negative value.

CPU Voltage [Auto]

Allows you to set the Offset voltage. The values range from -0.635V to +0.635V with a 0.005V interval.



Refer to the CPU documentation before setting the CPU voltage. Setting a high voltage may damage the CPU permanently, and setting a low voltage may make the system unstable.

2.4.9 iGPU Offset Mode Sign [+]

[+] To offset the voltage by a positive value.

[-] To offset the voltage by a negative value.

iGPU Voltage [Auto]

Allows you to set the Offset voltage. The values range from -0.635V to +0.635V with a 0.005V interval.

2.4.10 DRAM Voltage [Auto]

Allows you to set the DRAM voltage. The values range from 1.185V to 2.135V with a 0.005V interval.



According to Intel CPU specification, DIMMs with voltage requirement over 1.65V may damage the CPU permanently. We recommend you install the DIMMs with the voltage requirement below 1.65V.

2.4.11 VCCIO Voltage [Auto]

Allows you to set the VCCIO voltage. The values range from 0.7350V to 1.6850V with a 0.005V interval.

2.4.12 1.8FSR Voltage [Auto]

Allows you to set the 1.8FSR voltage. The values range from 1.8000V to 1.9000V with a 0.1V interval

2.4.13 PCH Voltage [Auto]

Allows you to set the Platform Controller Hub voltage. The values range from 0.735V to 1.685V with a 0.005V interval.

2.4.14 Load-Line Calibration [Auto]

Allows you to set the CPU Load-Line percentage.

Configuration options: [Auto] [Disabled] [Enabled]

2.4.15 CPU Spread Spectrum [Auto]

[Auto] Automatic configuration.

[Disabled] Enhances the BCLK overlocking ability.

[Enabled] Sets to [Enabled] for EMI control.

2.5 Advanced menu

The Advanced menu items allow you to change the settings for the CPU and other system devices.



Be cautious when changing the settings of the Advanced menu items. Incorrect field values can cause the system to malfunction.

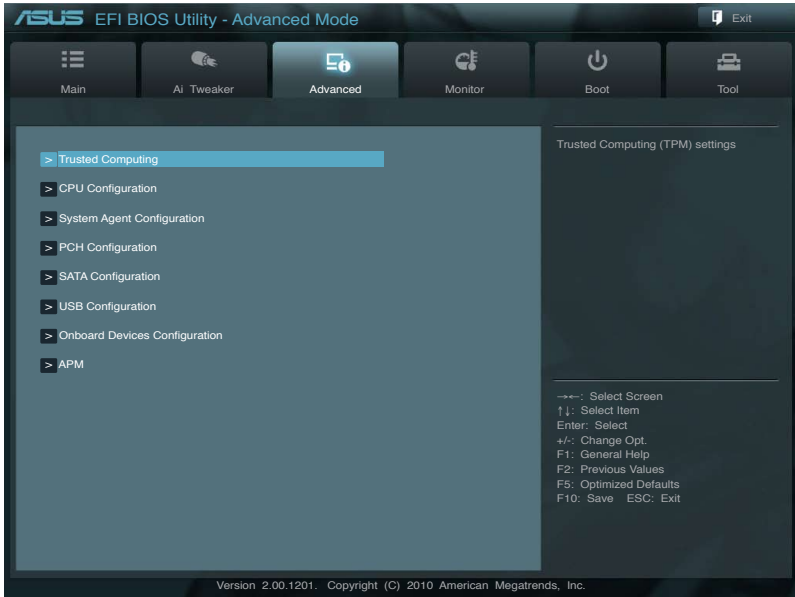

2.5.1 Trusted Computing

The Trusted Computing menu allows you to change TPM settings.

TPM Support [Disabled]

Allows you to enable or disable TPM support. Configuration options: [Disabled] [Enabled]

2.5.2 CPU Configuration

The items in this menu show the CPU-related information that the BIOS automatically detects.



The items shown in submenu may be different due to the CPU you installed.

CPU Ratio [Auto]

Allows you to set the ratio between the CPU Core Clock and the BCLK Frequency. Use <+> and <-> keys or the numeric keypad to adjust the ratio. The valid value ranges vary according to your CPU model.

Intel Adaptive Thermal Monitor [Enabled]

[Enabled] Enables the overheated CPU to throttle its clock speed to cool down.

[Disabled] Disables the CPU thermal monitor function.

Hyper-threading [Enabled]

The Intel Hyper-Threading Technology allows a hyper-threading processor to appear as two logical processors to the operating system, allowing the operating system to schedule two threads or processes simultaneously.

[Enabled] Two threads per activated core are enabled.

[Disabled] Only one thread per activated core is enabled.

Active Processor Cores [All]

Allows you to choose the number of CPU cores to activate in each processor package. Configuration options: [All] [1] [2] [3]

Limit CPUID Maximum [Disabled]

[Enabled] Allows legacy operating systems to boot even without support for CPUs with extended CPUID functions.

[Disabled] Disables this function.

Execute Disable Bit [Enabled]

[Enabled] Enables the No-Execution Page Protection Technology.

[Disabled] Forces the XD feature flag to always return to zero (0).

Intel(R) Virtualization Technology [Disabled]

[Enabled] Allows a hardware platform to run multiple operating systems separately and simultaneously, enabling one system to virtually function as several systems.

[Disabled] Disables this function.

Enhanced Intel SpeedStep Technology [Enabled]

Allows you to enable or disable the Enhanced Intel® SpeedStep Technology (EIST).

[Disabled] The CPU runs at its default speed.

[Enabled] The operating system controls the CPU speed.

Turbo Mode [Enabled]

This item appears only when you set the **Enhanced Intel SpeedStep Technology** item to [Enabled] and allows you to enable or disable the Intel® Turbo Mode Technology.

[Enabled] Allows processor cores to run faster than marked frequency in specific condition.

[Disabled] Disables this function.

CPU C1E [Enabled]

[Enabled] Enables the C1E support function. This item should be enabled in order to enable the Enhanced Halt State.

[Disabled] Disables this function.

CPU C3 Report [Disabled]

Allows you to disable or enable the CPU C3 report to OS.

Configuration options: [Disabled] [Enabled]

CPU C6 Report [Enabled]

Allows you to disable or enable the CPU C6 report to OS.

Configuration options: [Enabled] [Disabled]

2.5.3 System Agent Configuration

The System Agent Configuration menu allows you to change the System Agent settings.

Initiate Graphic Adapter [PEG/PCI]

Allows you to decide which graphics controller to use as the primary boot device.

Configuration options: [PCI/PEG] [PEG/PCI] [iGPU] [PCI/iGPU] [PEG/iGPU]

iGPU Memory [64M]

Allows you to set the Internal Graphics Device share memory size.

Configuration options: [32M] [64M] [96M] [128M]

Render Standby [Enabled]

Allows you to enable or disable Render Standby by Internal Graphics Device.

Configuration options: [Disabled] [Enabled]

iGPU Multi-Monitor [Disabled]

Allows you enable or disable Internal Graphics Device Multi-Monitor Support for add-on VGA devices. Configuration options: [Enabled] [Disabled]

2.5.4 PCH Configuration

The South Bridge menu allows you to change the PCH settings.

High Precision Timer [Enabled]

Allows you to enable or disable the High Precision Event Timer.

Configuration options: [Enabled] [Disabled]

2.5.5 SATA Configuration

While entering Setup, the BIOS automatically detects the presence of SATA devices. The SATA Port items show **Not Present** if no SATA device is installed to the corresponding SATA port.

SATA Mode [IDE Mode]

Allows you to set the SATA configuration.

[Disabled] Disables the SATA function.

[IDE Mode] Set to [IDE Mode] when you want to use the Serial ATA hard disk drives as Parallel ATA physical storage devices.

[AHCI Mode] Set to [AHCI Mode] when you want the SATA hard disk drives to use the AHCI (Advanced Host Controller Interface). The AHCI allows the onboard storage driver to enable advanced Serial ATA features that increases storage performance on random workloads by allowing the drive to internally optimize the order of commands.

[RAID Mode] Set to [RAID Mode] when you want to create a RAID configuration from the SATA hard disk drives.

Serial-ATA Controller 0 [Enhanced]

Allows you to set the SATA Controller 0. Configuration options: [Disabled] [Enhanced] [Compatible]

Serial-ATA Controller 1 [Enhanced]

Allows you to set the SATA Controller 1. Configuration options: [Disabled] [Enhanced] [Compatible]

S.M.A.R.T. Status Check [Enabled]

S.M.A.R.T. (Self-Monitoring, Analysis and Reporting Technology) is a monitor system. When read/write of your hard disk errors occur, this feature allows the hard disk to report warning messages during the POST. Configuration options: [Enabled] [Disabled]

2.5.6 USB Configuration

The items in this menu allow you to change the USB-related features.



The **USB Devices** item shows the auto-detected values. If no USB device is detected, the item shows None.

Legacy USB Support [Enabled]

[Enabled] Enables the support for USB devices.

[Disabled] The USB devices can be used only for the BIOS setup program.

[Auto] Sets to default settings.

Legacy USB3.0 Support [Enabled]

- [Enabled] Enables the support for USB3.0 devices.
- [Disabled] The USB3.0 devices can be used only for the BIOS setup program.

EHCI Hand-off [Disabled]

- [Enabled] Enables the support for operating systems without an EHCI hand-off feature.
- [Disabled] Disables the function.

2.5.7 Onboard Devices Configuration

HD Audio Controller [Enabled]

- [Enabled] Enables the High Definition Audio Controller.
- [Disabled] Disables the controller.



The following two items appear only when you set the **HD Audio Controller** item to [Enabled].

Front Panel Type [HD]

Allows you to set the front panel audio connector (AAFP) mode to legacy AC'97 or high-definition audio depending on the audio standard that the front panel audio module supports.

- [HD] Sets the front panel audio connector (AAFP) mode to high definition audio.
- [AC97] Sets the front panel audio connector (AAFP) mode to legacy AC'97

SPDIF Out Type [SPDIF]

Allows you to select the digital audio output type. Configuration options: [SPDIF] [HDMI]

VIA Storage Controller [Enabled]

- [Enabled] Enables the VIA storage controller.
- [Disabled] Disables the controller.

VIA Storage OPROM [Enabled]

This item appears only when the VIA Storage Controller item is set to [Enabled].

- [Enabled] Enables the VIA Storage OPROM.
- [Disabled] Disables the VIA Storage OPROM.

Realtek LAN Controller [Enabled]

- [Enabled] Enables the Realtek LAN controller.
- [Disabled] Disables the controller.

Realtek PXE ROM [Disabled]

This item appears only when you set the **Realtek LAN Controller** item to [Enabled] and allows you to enable or disable the Rom Help of the Realtek LAN controller.

Configuration options: [Enabled] [Disabled]

Asmedia USB 3.0 Controller [Enabled]

[Enabled] Enables the onboard USB 3.0 controller.

[Disabled] Disables the controller.



The following one item appear only when the **Asmedia USB 3.0 Controller** item is set to [Enabled].

Asmedia USB 3.0 Battery Charging Support [Enabled]

[Enabled] Enables the Asmedia USB 3.0 battery charging function.

[Disabled] Disables this function

Serial Port Configuration

The sub-items in this menu allow you to set the serial port configuration.

Serial Port [Enabled]

Allows you to enable or disable the serial port (COM).

Configuration options: [Enabled] [Disabled]

Change Settings [IO=3F8h; IRQ=4]

Allows you to select the Serial Port base address. Configuration options: [IO=3F8h; IRQ=4] [IO=2F8h; IRQ=3] [IO=3E8h; IRQ=4] [IO=2E8h; IRQ=3]

Parallel Port Configuration

The sub-items in this menu allow you to set the parallel port configuration.

Parallel Port [Enabled]

Allows you to enable or disable the parallel port (LPT).

Configuration options: [Enabled] [Disabled]

Change Settings [Auto]

Allows you to select the Parallel Port base address. Configuration options: [Auto] [IO=378h; IRQ=5] [IO=378h; IRQ=5,6,7,9,10,11,12] [IO=278h; IRQ=5,6,7,9,10,11,12] [IO=3BCh; IRQ= 5,6,7,9,10,11,12]

Device Mode

Allows you to change the printer port mode. Configuration options: [STD Printer Mode] [SPP Mode] [EPP-1.9 and SPP Mode] [EPP-1.7 and SPP Mode] [ECP Mode] [ECP and EPP 1.9 Mode] [ECP and EPP 1.7 Mode]

2.5.8 APM

Restore AC Power Loss [Power Off]

- [Power On] The system goes into on state after an AC power loss.
- [Power Off] The system goes into off state after an AC power loss.
- [Last State] The system goes into either off or on state, whatever the system state was before the AC power loss.

Power On By PS/2 Keyboard [Disabled]

- [Disabled] Disables the Power On by a PS/2 keyboard.
- [Space Bar] Sets the Space Bar on the PS/2 keyboard to turn on the system.
- [Ctrl-Esc] Sets the Ctrl+Esc key on the PS/2 keyboard to turn on the system.
- [Power Key] Sets Power key on the PS/2 keyboard to turn on the system. This feature requires an ATX power supply that provides at least 1A on the +5VSB lead.

Power On By PS/2 Mouse [Disabled]

- [Disabled] Disables the Power On by a PS/2 mouse.
- [Enabled] Enables the Power On by a PS/2 mouse. This feature requires an ATX power supply that provides at least 1A on the +5VSB lead.

Power On By PCI [Disabled]

- [Disabled] Disables the PME to wake up from S5 by PCI devices.
- [Enabled] Allows you to turn on the system through a PCI LAN or modem card. This feature requires an ATX power supply that provides at least 1A on the +5VSB lead.

Power On By PCIE [Disabled]

- [Disabled] Disables the PCIE devices to generate a wake event.
- [Enabled] Enables the PCIE devices to generate a wake event.

Power On By Ring [Disabled]

- [Disabled] Disables Ring to generate a wake event.
- [Enabled] Enables Ring to generate a wake event.

Power On By RTC [Disabled]

- [Disabled] Disables RTC to generate a wake event.
- [Enabled] When set to [Enabled], the items **RTC Alarm Date (Days)** and **Hour/Minute/Second** will become user-configurable with set values.

2.6 Monitor menu

The Monitor menu displays the system temperature/power status, and allows you to change the fan settings.

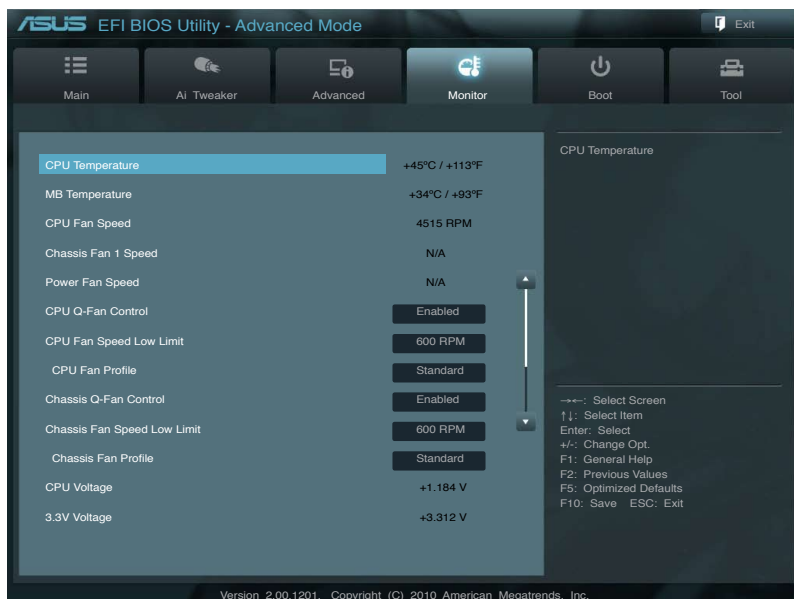

Scroll down to display the following items:

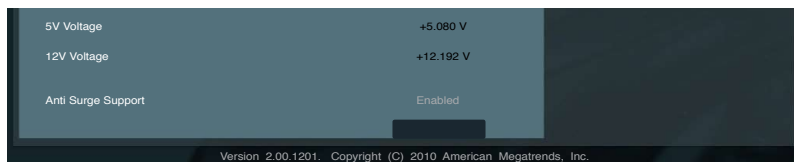

2.6.1 CPU Temperature / MB Temperature [xxx°C/xxx°F]

The onboard hardware monitor automatically detects and displays the CPU and motherboard temperatures. Select **Ignore** if you do not wish to display the detected temperatures.

2.6.2 CPU / Chassis / Power Fan Speed [xxxx RPM] or [Ignore] / [N/A]

The onboard hardware monitor automatically detects and displays the CPU, chassis, and power fan speeds in rotations per minute (RPM). If the fan is not connected to the motherboard, the field shows **N/A**. Select **Ignore** if you do not wish to display the detected speed.

2.6.3 CPU Q-Fan Control [Enabled]

[Disabled] Disables the CPU Q-Fan control feature.

[Enabled] Enables the CPU Q-Fan control feature.

CPU Fan Speed Low Limit [600 RPM]

This item appears only when you enable the **CPU Q-Fan Control** feature and allows you to disable or set the CPU fan warning speed.

Configuration options: [Ignore] [200 RPM] [300 RPM] [400 RPM] [500 RPM] [600 RPM]

CPU Fan Profile [Standard]

This item appears only when you enable the **CPU Q-Fan Control** feature and allows you to set the appropriate performance level of the CPU fan.

[Standard] Sets to [Standard] to make the CPU fan automatically adjust depending on the CPU temperature.

[Silent] Sets to [Silent] to minimize the fan speed for quiet CPU fan operation.

[Turbo] Sets to [Turbo] to achieve maximum CPU fan speed.

[Manual] Sets to [Manual] to assign detailed fan speed control parameters.



The following four items appear only when you set **CPU Fan Profile** to [Manual].

CPU Upper Temperature [70°C]

Use the <+> and <-> keys to adjust the upper limit of the CPU temperature. The values range from 20°C to 75°C.

CPU Fan Max. Duty Cycle(%) [100%]

Use the <+> and <-> keys to adjust the maximum CPU fan duty cycle. The values range from 20% to 100%. When the CPU temperature reaches the upper limit, the CPU fan will operate at the maximum duty cycle.

CPU Lower Temperature [20°C]

Use the <+> and <-> keys to adjust the low limit of CPU temperature. The values range 20°C to 75°C.

CPU Fan Min. Duty Cycle(%) [20%]

Use the <+> and <-> keys to adjust the minimum CPU fan duty cycle. The values range from 0% to 100%. When the CPU temperature is under the lower limit, the CPU fan will operate at the minimum duty cycle.

2.6.4 Chassis Q-Fan Control [Enabled]

[Disabled] Disables the Chassis Q-Fan control feature.

[Enabled] Enables the Chassis Q-Fan control feature.

Chassis Fan Speed Low Limit [600 RPM]

This item appears only when you enable the **Chassis Q-Fan Control** feature and allows you to disable or set the chassis fan warning speed.

Configuration options: [Ignore] [200 RPM] [300 RPM] [400 RPM] [500 RPM] [600 RPM]

Chassis Fan Profile [Standard]

This item appears only when you enable the **Chassis Q-Fan Control** feature and allows you to set the appropriate performance level of the chassis fan.

- [Standard] Sets to [Standard] to make the chassis fan automatically adjust depending on the chassis temperature.
- [Silent] Sets to [Silent] to minimize the fan speed for quiet chassis fan operation.
- [Turbo] Sets to [Turbo] to achieve maximum chassis fan speed.
- [Manual] Sets to [Manual] to assign detailed fan speed control parameters.



The following four items appear only when you set **Chassis Fan Profile** to [Manual].

Chassis Upper Temperature [70°C]

Use the <+> and <-> keys to adjust the upper limit of the CPU temperature. The values range from 40°C to 90°C.

Chassis Fan Max. Duty Cycle(%) [100%]

Use the <+> and <-> keys to adjust the maximum chassis fan duty cycle. The values range from 60% to 100%. When the chassis temperature reaches the upper limit, the chassis fan will operate at the maximum duty cycle.

Chassis Lower Temperature [40°C]

Displays the lower limit of the chassis temperature.

CPU Fan Min. Duty Cycle(%) [60%]

Use the <+> and <-> keys to adjust the minimum chassis fan duty cycle. The values range from 60% to 100%. When the chassis temperature is under 40°C, the chassis fan will operate at the minimum duty cycle.

2.6.5 CPU Voltage, 3.3V Voltage, 5V Voltage, 12V Voltage

The onboard hardware monitor automatically detects the voltage output through the onboard voltage regulators. Select **Ignore** if you do not want to detect this item.

2.6.6 Anti Surge Support [Enabled]

This item allows you to enable or disable the Anti Surge function.

Configuration options: [Disabled] [Enabled]

2.7 Boot menu

The Boot menu items allow you to change the system boot options.

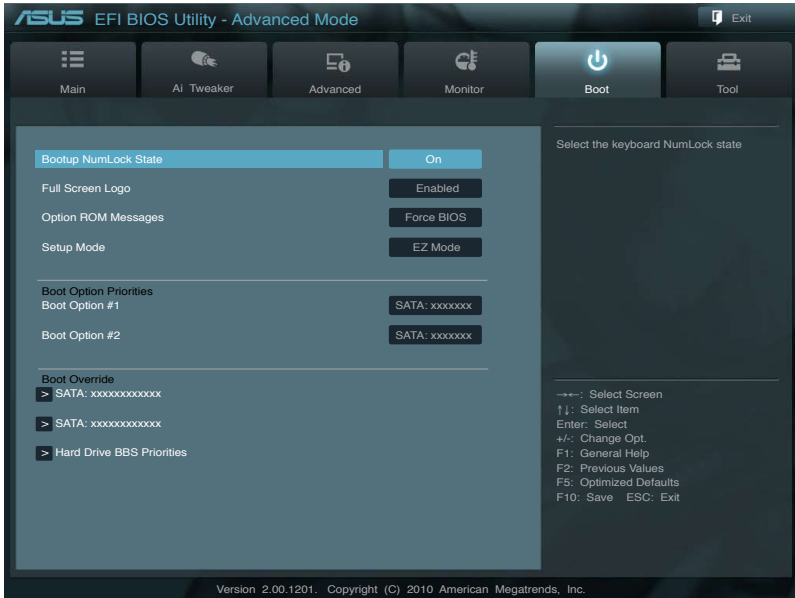

2.7.1 Bootup NumLock State [On]

[On] Sets the power-on state of the NumLock to [On].

[Off] Sets the power-on state of the NumLock to [Off].

2.7.2 Full Screen Logo [Enabled]

[Enabled] Enables the full screen logo display feature.

[Disabled] Disables the full screen logo display feature.



Set this item to [Enabled] to use the ASUS MyLogo 2™ feature.

2.7.3 Post Report [5 sec]

Allows you to set the waiting time for the system to display the post report. This item appears only when the **Full Screen Logo** item is set to **[Disabled]**.

Configuration options: [1 sec] [2 sec] [3 sec] [4 sec] [5 sec] [6 sec] [7 sec] [8 sec] [9 sec] [10 sec] [Until Press ESC]

2.7.4 Option ROM Messages [Force BIOS]

[Force BIOS] The third-party ROM messages will be forced to display during the boot sequence.

[Keep Current] The third-party ROM messages will be displayed only if the third-party manufacturer had set the add-on device to do so.

2.7.5 Setup Mode [EZ Mode]

[Advanced Mode] Sets Advanced Mode as the default screen for entering the BIOS setup program.

[EZ Mode] Sets EZ Mode as the default screen for entering the BIOS setup program.

2.7.6 Boot Option Priorities

These items specify the boot device priority sequence from the available devices. The number of device items that appears on the screen depends on the number of devices installed in the system.



- To select the boot device during system startup, press <F8> when ASUS Logo appears.
 - To access Windows OS in Safe Mode, do any of the following:
 - Press <F5> when ASUS Logo appears.
 - Press <F8> after POST.
-

2.7.7 Boot Override

These items displays the available devices. The number of device items that appears on the screen depends on the number of devices installed in the system. Click an item to start booting from the selected device.

2.8 Tools menu

The Tools menu items allow you to configure options for special functions. Select an item then press <Enter> to display the submenu.

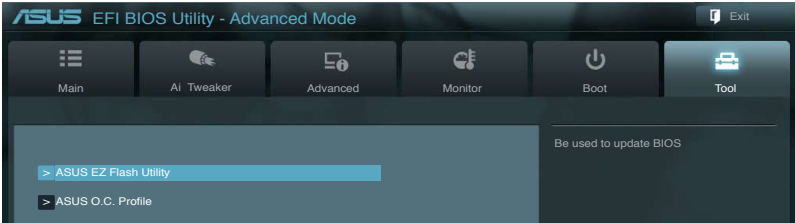

2.8.1 ASUS EZ Flash 2

Allows you to run ASUS EZ Flash 2. When you press <Enter>, ASUS EZ Flash 2 screen appears.



For more details, refer to section 2.1.2 **ASUS EZ Flash 2**.

2.8.2 ASUS O.C. Profile

This item allows you to store or load multiple BIOS settings.



The **Setup Profile Status** items show **Not Installed** if no profile is created.

Save to Profile

Allows you to save the current BIOS settings to the BIOS Flash, and create a profile. Key in a profile number from one to eight, press <Enter>, and then select **Yes**.

Load from Profile

Allows you to load the previous BIOS settings saved in the BIOS Flash. Key in the profile number that saved your CMOS settings, press <Enter>, and then select **Yes**.



-
- DO NOT shut down or reset the system while updating the BIOS to prevent the system boot failure!
 - We recommend that you update the BIOS file only coming from the same memory/CPU configuration and BIOS version.
-

2.9 Exit menu

The Exit menu items allow you to load the optimal default values for the BIOS items, and save or discard your changes to the BIOS items. You can access the **EZ Mode** from the Exit menu.

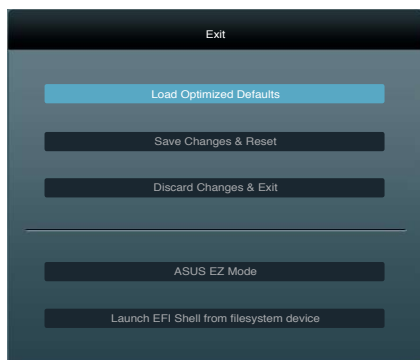

Load Optimized Defaults

This option allows you to load the default values for each of the parameters on the Setup menus. When you select this option or if you press <F5>, a confirmation window appears. Select **Yes** to load the default values.

Save Changes & Reset

Once you are finished making your selections, choose this option from the Exit menu to ensure the values you selected are saved. When you select this option or if you press <F10>, a confirmation window appears. Select **Yes** to save changes and exit.

Discard Changes & Exit

This option allows you to exit the Setup program without saving your changes. When you select this option or if you press <Esc>, a confirmation window appears. Select **Yes** to discard changes and exit.

ASUS EZ Mode

This option allows you to enter the EZ Mode screen.

Launch EFI Shell from filesystem device

This option allows you to attempt to launch the EFI Shell application (shellx64.efi) from one of the available filesystem devices.

ASUS contact information

ASUSTeK COMPUTER INC.

Address	15 Li-Te Road, Peitou, Taipei, Taiwan 11259
Telephone	+886-2-2894-3447
Fax	+886-2-2890-7798
E-mail	info@asus.com.tw
Web site	www.asus.com.tw

Technical Support

Telephone	+86-21-38429911
Online support	support.asus.com

ASUS COMPUTER INTERNATIONAL (America)

Address	800 Corporate Way, Fremont, CA 94539, USA
Telephone	+1-510-739-3777
Fax	+1-510-608-4555
Web site	usa.asus.com

Technical Support

Telephone	+1-812-282-2787
Support fax	+1-812-284-0883
Online support	support.asus.com

ASUS COMPUTER GmbH (Germany and Austria)

Address	Harkort Str. 21-23, D-40880 Ratingen, Germany
Fax	+49-2102-959911
Web site	www.asus.de
Online contact	www.asus.de/sales

Technical Support

Telephone (Component)	+49-1805-010923*
Telephone (System/Notebook/Eee/LCD)	+49-1805-010920*
Support Fax	+49-2102-9599-11
Online support	support.asus.com

* EUR 0.14/minute from a German fixed landline; EUR 0.42/minute from a mobile phone.

DECLARATION OF CONFORMITY

Per FCC Part 2, Section 2.1077(a)



Responsible Party Name: **Asus Computer International**

Address: **800 Corporate Way, Fremont, CA 94539.**

Phone/Fax No: **(510)739-3777/(510)608-4555**

hereby declares that the product

Product Name : Motherboard

Model Number : P8H67-M PRO

Conforms to the following specifications:

- FCC Part 15, Subpart B, Unintentional Radiators
- FCC Part 15, Subpart C, Intentional Radiators
- FCC Part 15, Subpart E, Intentional Radiators

Supplementary Information:

This device complies with part 15 of the FCC Rules. Operation is subject to the following two conditions: (1) This device may not cause harmful interference, and (2) this device must accept any interference received, including interference that may cause undesired operation.

Representative Person's Name : Steve Chang / President

Signature :

Date : Oct. 21, 2010

EC Declaration of Conformity



We, the undersigned,

Manufacturer: ASUSTek COMPUTER INC.
Address, City: No. 150, LI-TE RD., PEITOU, TAIPEI 112, TAIWAN R.O.C.
Country: TAIWAN
Authorized representative in Europe: ASUS COMPUTER GmbH
Address, City: HARKORT STR. 21-23, 40880 RATINGEN
Country: GERMANY

declare the following apparatus:

Product name : Motherboard
Model name : P8H67-M PRO

conform with the essential requirements of the following directives:

2004/108/EC-EMC Directive
 EN 55024:2007
 EN 61000-3-2:2006
 EN 55013:2001+A1:2003+A2:2006
 EN 55020:2007

1999/5/EC-R & TTE Directive
 EN 300 328 V1.7.1(2006-05)
 EN 300 440-1 V1.4 (2006-05)
 EN 300 440-2 V1.4 (2006-05)
 EN 301 119 V0.2 (2003-03)
 EN 301 489-1 V1.3 (2005-11)
 EN 301 489-4 V1.4 (2007-11)
 EN 301 489-7 V1.3 (2005-11)
 EN 301 489-9 V1.4 (2007-11)
 EN 301 489-11 V1.3 (2006-04)
 EN 301 489-12 V1.3 (2006-04)
 EN 301 489-14 (2005-05)
 EN 50860:2001
 EN 50837:2002
 EN 50838:2002
 EN 50839:2002

2006/95/EC-LVD Directive
 EN 60950-1:2001+A11:2004
 EN 60950-1:2006
 EN 60950-1:2006+A11:2009

2009/125/EC-EP- Directive
Regulation (EC) No. 1275/2008
 EN 62301:2005
Regulation (EC) No. 642/2009
 EN 62301:2005



CE marking

(EC conformity marking)

Position : CEO
Name : Jerry Shen

Signature : _____

Declaration Date: Oct. 21, 2010
Year to begin affixing CE marking: 2010